



KONICA MINOLTA

bizhub C759/C659, AccurioPrint C759 QUICK GUIDE





Table of contents

1 Introduction

1.1	Environmental information	1-4
	Environmental initiatives	1-4
	ENERGY STAR®.....	1-4
	What is an ENERGY STAR® product?	1-4
	Environmental benefits of power management	1-4
	Recycled paper	1-4
	Duplex printing.....	1-4
1.2	Certification for USA, Canada, Mexico, Brazil and Europe area	1-5
	For U.S.A.....	1-5
	For Canada	1-5
	For Mexico	1-5
	For Brazil	1-5
	For Europe	1-5
1.3	Safety information	1-6
	Warning and precaution symbols	1-6
	These are some of major exemplary graphical symbols	1-6
	Power source connection	1-7
	Installation.....	1-8
	Using the product	1-9
	Consumables	1-11
1.4	Regulation notices	1-12
	CE Marking (Declaration of Conformity) for users of the European Union (EU).....	1-12
	USER INSTRUCTIONS FCC PART 15 - RADIO FREQUENCY DEVICES (for U.S.A. users).....	1-12
	INTERFERENCE-CAUSING EQUIPMENT STANDARD (ICES-003 ISSUE 5) (for Canada users)....	1-13
	For users in countries not subject to class B regulations	1-13
	GS Certification.....	1-13
	Laser safety.....	1-13
	Internal laser radiation.....	1-13
	CDRH regulations	1-14
	For European users.....	1-14
	Laser safety label	1-14
	Ozone release	1-14
	Acoustic noise (for European users only).....	1-15
	For EU member states only	1-15
	Telephone cable (for users in countries subject to class B regulations).....	1-15
	USB Host	1-15
	Graphic symbols used on this machine.....	1-16
1.5	Caution notations and labels	1-17
1.6	Special notice to user	1-18
	For Europe	1-18
1.7	Space requirements	1-19
1.8	Operation precautions	1-21
	Power source	1-21
	Operating environment	1-21
	Storage of copies.....	1-21
	Data stored in this machine	1-21
1.9	Legal restrictions on reproduction	1-22
1.10	Trademark acknowledgements	1-23
	Copyright	1-24
	Note	1-24
1.11	SOFTWARE LICENSE AGREEMENT	1-25
1.12	i-Option LK-105 v4 (Searchable PDFs) End User License Agreement	1-27

2 About this machine

2.1	Intended use of office MFP devices	2-3
	Intended use	2-3
	Impermissible operating conditions	2-3
	Exclusion of liability	2-3
2.2	Introduction to user's guide	2-4
2.2.1	[Quick Guide] (this manual)	2-4
2.2.2	User's Guide CD/DVD	2-4
	Layout of top page	2-4
	Operating environment	2-5
2.2.3	Target groups	2-5
2.2.4	Symbols and notations used in this manual	2-5
	Procedural instruction	2-5
	Symbols and notations	2-6
	Screens	2-6
	Names and notations of applications	2-6
2.3	About this machine	2-7
2.3.1	Optional components	2-7
	List of optional components	2-7
	List of other optional components	2-9
2.3.2	Name of parts (MFP)	2-10
	Front	2-10
	Side/rear	2-11
2.3.3	Name of parts (Optional units)	2-12
	Finisher FS-537/Finisher FS-537 SD/Punch Kit PK-523/Z Folding Unit ZU-609	2-12
	Job Separator JS-602	2-14
	Post Inserter PI-507	2-15
	Finisher FS-536/Finisher FS-536 SD/Punch Kit PK-520	2-16
	Large Capacity Unit LU-303/LU-205	2-18
2.4	Power supply	2-19
2.4.1	Turning the power on and off	2-19
2.4.2	Operating the Power key	2-20
2.4.3	Power save function	2-21
	Reducing power consumption	2-21
2.5	Control Panel	2-22
2.5.1	Name of parts	2-22
2.6	Touch Panel	2-24
2.6.1	Main Menu	2-24
	Layout of main menu	2-24
	Customizing the main menu	2-25
2.6.2	Slide menu	2-25
	Customizing the slide menu	2-25
2.6.3	Operating the Touch Panel	2-26
	Tap	2-26
	Double-tap	2-26
	Flick	2-26
	Drag	2-27
	Pan	2-27
	Long-tap	2-27
	Drag & Drop	2-28
	Pinch-in / Pinch-out	2-28
	Rotation	2-28
	Precautions for using the Touch Panel	2-29
2.6.4	How to display the Keypad	2-29
	How to move the Keypad	2-30
	How to close the Keypad	2-30
	To display the Keypad all the time	2-30
2.6.5	Entering characters	2-31
	When typing in "Group1":	2-31



2.7	Jobs	2-32
2.7.1	Job screen	2-32
2.7.2	Multi-job function	2-32
2.8	Loading Paper	2-33
2.8.1	Loading paper in Tray 1 to Tray 2	2-33
	Applicable paper types	2-33
	Applicable paper sizes	2-33
	How to load paper	2-33
2.8.2	Loading paper in Tray 3 to Tray 4	2-34
	Applicable paper types	2-34
	Applicable paper sizes	2-34
	How to load paper	2-35
2.8.3	Loading paper into the Large Capacity Unit	2-36
	Applicable paper types	2-36
	Applicable paper sizes	2-36
	How to load paper	2-36
2.8.4	Bypass Tray	2-37
	Applicable paper types	2-37
	Applicable paper sizes	2-37
	Paper not available	2-38
	How to load paper	2-38
	Loading postcards	2-39
	Loading transparencies	2-41
	Loading envelopes	2-42
	Loading label sheets	2-44
	Loading index papers	2-45

3 Basic Settings and Operations

3.1	Print function	3-3
3.1.1	Required settings and basic operations (for Windows OS)	3-3
	Preparation flow	3-3
	Operation flow	3-4
	Checking the cable connection	3-4
	Checking network settings of this machine	3-4
	Installing the printer driver	3-5
	Printing data	3-5
	Types of printer drivers	3-5
3.1.2	Required settings and basic operations (for Mac OS)	3-6
	Preparation flow	3-6
	Operation flow	3-7
	Checking the cable connection	3-7
	Checking network settings of this machine	3-7
	Installing the printer driver	3-9
	Adding and configuring a printer driver	3-9
	Printing data	3-10
3.2	Scan-to-Send function	3-11
3.2.1	Various transmission methods	3-11
	Sending data to your computer (SMB Send)	3-11
	Transmitting data as E-mail attachment (E-mail TX)	3-11
	Saving data to the USB memory device (External memory)	3-11
	Various methods for transmitting and saving data	3-12
3.2.2	Sending data to your Windows computer (SMB Send)	3-12
	Preparation flow	3-13
	Operation flow	3-13
	Checking the cable connection	3-13
	Checking network settings of this machine	3-14
	Checklist	3-14
	Checking computer information	3-15
	Configuring your computer	3-15
	Registering destinations	3-16
	Sending the original	3-18

3.2.3	Sending data to your Mac computer (SMB Send).....	3-20
	Preparation flow.....	3-20
	Operation flow.....	3-21
	Checking the cable connection.....	3-21
	Checking network settings of this machine.....	3-21
	Configuring this machine.....	3-22
	Checklist.....	3-23
	Checking computer information.....	3-23
	Configuring your computer.....	3-23
	Registering destinations.....	3-24
	Sending the original.....	3-26
3.2.4	Transmit the scanned data via E-mail (E-mail TX).....	3-28
	Preparation flow.....	3-28
	Operation flow.....	3-29
	Checking the cable connection.....	3-29
	Checking network settings of this machine.....	3-29
	Configuring the E-mail transmission environment.....	3-30
	Configuring administrator information.....	3-32
	Sending the original.....	3-33
3.3	Fax function.....	3-36
3.3.1	Required settings and basic operations.....	3-36
	Preparation flow.....	3-36
	Operation flow.....	3-37
	Checking the cable connection.....	3-37
	Registering transmission information.....	3-37
	Selecting the dialing method.....	3-39
	Sending the original.....	3-40
3.3.2	Sending a fax directly from a PC (PC-FAX TX).....	3-42
	Preparation flow.....	3-43
	Operation flow.....	3-43
	Checking the cable connection.....	3-44
	Checking network settings of this machine.....	3-44
	Installing the fax driver.....	3-45
	Sending data.....	3-45
3.4	Copy function.....	3-46
	Basic operations.....	3-46
	User authentication.....	3-48
3.5	Registering a destination.....	3-49
3.5.1	Registering an address book.....	3-49
	Using the Control Panel to register an address book - Registration from [Utility].....	3-49
	Using the Control Panel to register an address book - Registration from [Address book].....	3-51
	Using the Control Panel to register an address book - Registration in scan/fax mode.....	3-53
	Using a computer to register a one-touch destination.....	3-56
3.5.2	Information required to register a destination.....	3-57
3.5.3	Registering a group.....	3-58
	Registering a new group.....	3-58
3.5.4	Retrieving a registered destination.....	3-60
	Retrieving a destination.....	3-60
	Specifying a destination.....	3-61
3.6	Using a USB memory device.....	3-62
3.6.1	Printing data in a USB memory device.....	3-62
	Printing data.....	3-62
3.6.2	Saving the scanned data in the USB memory device (External memory).....	3-64
	Specifying functions to be permitted for external memory.....	3-64
	Saving data in the USB memory device.....	3-65
3.7	Using the guidance function.....	3-68
3.7.1	Guidance screen.....	3-68
	Getting help on the currently displayed screen:.....	3-68
	Getting help on the desired function or procedure:.....	3-70
	Help Menu list.....	3-72



3.8	Using the [Quick Security] function	3-73
3.8.1	[Quick Security].....	3-73
	Required settings.....	3-73

4 Advanced Functions

4.1	Using advanced functions.....	4-3
4.1.1	What are advanced functions?	4-3
4.1.2	Association with application	4-4
4.1.3	Registering the i-Option license.....	4-4
	Preparation flow.....	4-4
	Enabling the i-Option function	4-5
	Registering the i-Option license.....	4-6
	Enabling the i-Option function using the license (Administrator).....	4-8
	Configuring each function.....	4-9
4.2	Using the Web browser function	4-10
4.2.1	Required settings and procedures.....	4-10
	Preparation flow.....	4-10
	Operation flow.....	4-11
	Enabling the Web browser function.....	4-11
	Registering the license.....	4-12
	Enabling the Web browser using the license.....	4-13
	Starting the Web browser	4-17
	Displaying Web pages	4-17
	Printing the currently displayed page or the linked file.....	4-18

5 Troubleshooting

5.1	Main messages and remedies	5-3
5.1.1	When a message appears to replace consumables or carry out cleaning	5-3
5.1.2	When a paper jam message persists.....	5-4
5.1.3	When an error message appears.....	5-4
5.1.4	When [Stabilizing image.] appears.....	5-5
5.2	When printing quality has deteriorated.....	5-6
5.2.1	Cleaning the Print Head Glass.....	5-6
5.3	When the machine cannot be powered on.....	5-8
5.4	When the Touch Panel is not visible	5-9
5.5	When a message appears to replace consumables or carry out cleaning	5-10
	When staples in the Finisher have run out.....	5-10
	When the punch scrap box is full	5-11
	When toner is running out in the Toner Cartridge.....	5-11
	When it is time to replace a Toner Cartridge	5-12
	When it is time to replace an Imaging Unit	5-12
	When the Waste Toner Box is full.....	5-13
5.5.1	Replacing a Toner Cartridge.....	5-14
5.5.2	Replacing a Waste Toner Box	5-15
5.5.3	Replacing an Imaging Unit.....	5-16
5.5.4	Replacing a Staple Cartridge.....	5-17
	Finisher FS-537/Finisher FS-537 SD	5-17
	Finisher FS-536/Finisher FS-536 SD	5-18
5.5.5	Replacing a Saddle Staple Cartridge.....	5-19
	Finisher FS-537 SD.....	5-19
	Finisher FS-536 SD.....	5-20

6 Index





Introduction

1 Introduction

This [Quick Guide] uses illustrations to describe operating procedures for the most commonly used functions in an easy-to-understand way.

Start by using this manual to become proficient with the useful functions that this machine offers.

For details on the various functions, refer to the User's Guides on the User's Guide CD/DVD included with this machine.

In order to operate the machine safely and properly, be sure to read the safety information on page 1-6 of this manual before use.

In addition, this manual contains the following information. Be sure to read the manual before using the machine.

- Items that must be observed to use the machine safely
- Information regarding product safety
- Precautions when using the machine
- Descriptions on trademarks and copyrights

The illustrations and screens used in this manual may appear slightly different from views of the actual equipment and screens.

Tips

- Please keep this manual as well as the attached CD/DVD in a safe place where you can access them easily.

1.1 Environmental information

Environmental initiatives

The company continuously strives to reduce the negative environmental impacts of all stages of its business operations.

As part of such activities, the company is implementing resource-saving steps by reducing the number of pages in the User's Guide.

For the information necessary to operate the machine, please refer to the bundled User's Guide CD/DVD (HTML format). This guide has an excellent search function.

Functions such as keyword search and filtering by purpose are very useful to help users find what they need to know.

ENERGY STAR®



As an ENERGY STAR® Partner, this machine meets the ENERGY STAR® Guidelines for energy efficiency.

What is an ENERGY STAR® product?

An ENERGY STAR® product has a special feature that allows it to automatically switch to a "low-power mode" after a period of inactivity. An ENERGY STAR® product uses energy more efficiently, saves you money on utility bills and helps protect the environment.

Environmental benefits of power management

Electricity consumption of a device depends on both its properties and the way of using the device.

Suitable power management setting offers you resource saving usage way. By setting the time to go into power saving modes (e.g. sleep mode) shorter (or optimal), electricity consumption can be reduced.

Recycled paper

This product can print on recycled paper and environmental stewardship initiatives certified paper which complies with European standard EN 12281 as well as virgin paper. In addition it can print on lighter paper, 64g/m² for example. Using such light paper contributes to resources-saving.

Duplex printing

With a product which has a duplex unit, you can print on both sides of paper automatically.

Using this function leads to reducing consumption of natural resources and your cost.

Attached printer driver provides this duplex printing function as initial setting in your computer (The setting can be changed after installation manually).

1.2 Certification for USA, Canada, Mexico, Brazil and Europe area

For U.S.A

This product is certified by the following model name in U.S.A.

KONICA MINOLTA branded model C504501 (bizhub C759 and bizhub C659).

For Canada

This product is certified by the following model name in Canada.

KONICA MINOLTA branded model C504501 (bizhub C759 and bizhub C659).

For Mexico

This product is certified by the following model name in Mexico.

KONICA MINOLTA branded model C504501 (bizhub C759 and bizhub C659).

For Brazil

This product is certified by the following model name in Brazil.

KONICA MINOLTA branded model C504501 (bizhub C759 and bizhub C659).

For Europe

This product is certified by the following model name in Europe.

KONICA MINOLTA branded model C504501 (bizhub C759 and bizhub C659).

1.3 Safety information

This section contains detailed instructions on the operation and maintenance of this machine. To achieve optimum utility of this device, all operators should carefully read and follow the instructions in this manual.

Please read the following section before connecting the machine to the supply. It contains important information related to user safety and preventing equipment problems.

Make sure that you observe all of the precautions that appear in different sections of this manual.

Reference



- Some parts of the contents of this section may not correspond with the purchased product.

Warning and precaution symbols









Be sure to observe the safety precautions.

This manual contains the instructions that should be strictly observed at all times to prevent injury to yourself and other persons as well as damage to property.

Injuries and damage that might be caused by using the product improperly are classified according to the following symbols.









Pictorial indication	Description
 WARNING	Improper handling can cause serious injury or death.
 CAUTION	Improper handling can cause minor injury or damage to houses and property.

These are some of major exemplary graphical symbols



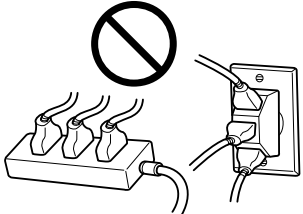
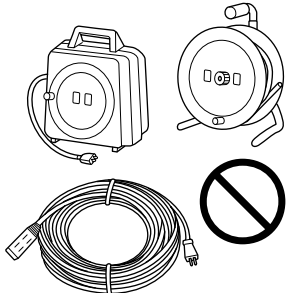

Graphic symbols	Descriptions	Graphic symbols	Descriptions	Graphic symbols	Descriptions
	General prohibition		Do not disassemble		Do not touch
	General instruction		Ground/Earth		Unplug from outlet
	General precaution		High temperature		Electrical shock hazard

Power source connection

⚠ WARNING

Descriptions	Graphic symbols
<p>Do not use any power cord other than the one supplied in the package or attached on the products. If a power cord is not supplied, use only the power cord and plug that are specified in the user documentation. Failure to use this cord could result in a fire or electrical shock. If the power cord supplied in the package cannot be used in the country where this product was sold, use a power cord that meets the following conditions or contact your Technical Representative.</p> <ul style="list-style-type: none"> • The power cord has voltage and current rating appropriate for the rating plate on this machine. • The power cord meets regulatory requirements for the area. • The power cord is provided with grounding pin/terminal. 	
<p>Do not use the power cord to other products. Failure to do that could result in a fire or electrical shock.</p>	
<p>Do not scratch, abrade, place a heavy object on, heat, twist, bend, step on, pull on, or damage the power cord. Use of a damaged power cord (exposed core wire, broken wire, etc.) could result in a fire or breakdown. Should any of these conditions be found, immediately turn OFF the power switch, unplug the power cord from the power outlet, and then call your authorized service representative.</p>	
<p>Do not use the power source voltage other than being specified on the machine. Failure to do that could result in a fire or electrical shock.</p>	
<p>Do not use a multiple outlet adapter to connect any other appliances or machines. Use of a power outlet for more than the marked current value could result in a fire or electrical shock.</p>	
<p>Do not use an extension cord. Use of an extension cord could cause a fire or electric shock. If the power cord furnished with the product is not long enough to be plugged into a wall outlet, contact your Technical Representative.</p>	
<p>Do not unplug and plug in the power cord with a wet hand, as an electrical shock could result.</p>	
<p>Plug the power cord all the way into the power outlet. Failure to do this could result in a fire or electrical shock.</p>	
<p>Make sure to ground this product. (Connect the power cord to an electrical outlet that is equipped with a grounding terminal.) Failure to do so and an unlikely event of leakage could result in a fire or electrical shock.</p>	

⚠ CAUTION





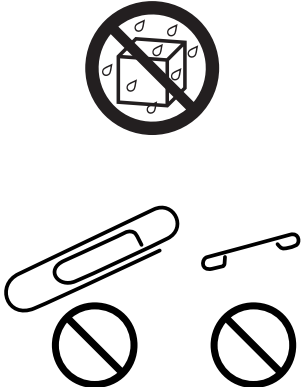
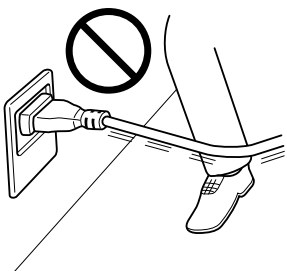

Descriptions	Graphic symbols
The outlet must be near the equipment and easily accessible. Otherwise you can not pull out the power plug when an emergency occurs.	
Do not place any objects around the power plug, as the power plug may be difficult to pull out when an emergency occurs.	
Do not tug the power cord when unplugging. Pulling on the power cord could damage the cord, resulting in a fire or electrical shock.	
Remove the power plug from the outlet more than one time a year and clean the area between the plug terminals. Dust that accumulates between the plug terminals may cause a fire.	

Installation

⚠ WARNING





Descriptions	Graphic symbols
Keep this bag away from babies and children. Do not use in cribs, beds, carriages, or playpens. The thin film may cling to nose and mouth and prevent breathing. This bag is not a toy.	
Do not place a flower vase or other container that contains water, or metal clips or other small metallic objects on this product. Spilled water or metallic objects dropped inside the product could result in a fire, electrical shock, or breakdown. Should a piece of metal, water, or any other similar foreign matter get inside the product, immediately turn OFF the power switch, unplug the power cord from the power outlet, and then call your Technical Representative or your authorized service representative.	
Make sure that the power cord is placed on a site in which no person would step on or trip over it. Stepping on or tripping over the power cord could heat the power cord, resulting in a fire or electric shock.	

⚠ CAUTION

Descriptions	Graphic symbols
<p><If instructed to use fixing legs> When the product has been installed, fix the product using the fixing legs. Not using the fixing legs could cause the product to move or topple over.</p>	
<p>Do not place the product in a dusty place, or a site exposed to soot or steam, near a kitchen table, bath, or a humidifier. A fire, electrical shock, or breakdown could result.</p>	
<p>Do not place this product on an unstable or tilted bench, or in a location subject to a lot of vibration and shock. It could drop or fall, causing personal injury or mechanical breakdown.</p>	
<p>Do not let any object plug the ventilation holes of this product. Heat could accumulate inside the product, resulting in a fire or malfunction.</p>	
<p>Whenever moving this product, be sure to disconnect the power cord and other cables. Failure to do this could damage the cord or cable, resulting in a fire, electrical shock, or breakdown.</p>	
<p>When moving this product, always hold it at the locations specified in the User's Guide or other documents. If the unit is moved while held at locations other than those specified, it may fall, causing severe personal injury.</p>	

Using the product

⚠ WARNING

Descriptions	Graphic symbols
<p>Do not modify this product, as a fire, electrical shock, or breakdown could result. If the product employs a laser, the laser beam source could cause blindness.</p>	
<p>Do not attempt to remove the covers and panels which have been fixed to the product. Some products have a high-voltage part or a laser beam source inside that could cause an electrical shock or blindness.</p>	
<p>Do not keep using this product, if this product becomes inordinately hot or emits smoke, or unusual odor or noise. Immediately turn OFF the power switch, unplug the power cord from the power outlet, and then call your Technical Representative or your authorized service representative. If you keep on using it as is, a fire or electrical shock could result.</p>	
<p>Do not keep using this product, if this product has been dropped or its cover damaged. Immediately turn OFF the power switch, unplug the power cord from the power outlet, and then call your Technical Representative or your authorized service representative. If you keep on using it as is, a fire or electrical shock could result.</p>	
<p>Do not use flammable sprays, liquids, or gases inside or near this machine. Do not clean the inside of this machine using a flammable gas duster. A fire or explosion could result.</p>	

⚠ WARNING

Descriptions

<If an RFID module (limited only to 13.56 MHz) for use in inside-the-machine proximity communication or electromagnetic induction heating (IH) technology (limited only to 20.05 kHz to 100 kHz) is being used>
This machine generates a weak magnetic field.
If you experience any unusual symptoms with your implantable medical equipment (cardiac pacemaker, etc.) while near the machine, move away from the machine and see a doctor immediately.
Please call your Technical Representative or your authorized service representative if you do not understand the purchased product corresponds or not.

Graphic symbols



<If a non-contact IC card reader is being used>
If you use an implantable medical equipment (cardiac pacemaker, etc.), do not bring the IC card reader close from the implant within 12 cm at all times.
The radio waves may affect implantable medical equipment (cardiac pacemaker, etc.) operations.



⚠ CAUTION

Descriptions

Using this product in a poorly ventilated room for a long time or producing a large volume of copies or prints may cause the odor of exhaust air from the machine. Ventilate the room well.

Graphic symbols



The inside of this product has areas subject to high temperature, which may cause burns.
When checking the inside of the unit for malfunctions such as a paper misfeed, do not touch the locations (around the fusing unit, etc.) which are indicated by a "Caution HOT" caution label. A burn could result.



Unplug the product when you will not use the product for long periods of time.



When using the machine, do not look at the light of the lamp for a prolonged time. Eyestrain could result.



Do not use stapled paper, conductive paper (such as silver paper or carbon paper) or treated heat-sensitive/inkjet paper, otherwise a fire may result.



Consumables

⚠ WARNING

Descriptions

Do not throw toner or a container that contains toner (e.g., toner cartridge, developing unit and Waste Toner Box) into an open flame. The hot toner may scatter and cause burns or other damage.

Graphic symbols



⚠ CAUTION

Descriptions

Do not leave toner-related parts (e.g., toner cartridge, developing unit and Waste Toner Box) within easy reach of children. Licking any of these parts or ingesting toner could damage your health.

Graphic symbols



Do not store toner-related parts (e.g., toner cartridge, developing unit and Waste Toner Box) near devices susceptible to magnetism, such as precision equipment and data storage devices, otherwise they may malfunction. They could cause these products to malfunction.



Do not force open the toner-related parts (e.g., toner cartridge, developing unit and Waste Toner Box). If toner tumbles from the toner bottle, take utmost care to avoid inhaling it or even getting skin contact.



If toner lands on your skin or clothing, wash thoroughly with soap and water.



If you inhale toner, move to a place with fresh air and gargle with a lot of water repeatedly. Should you get symptoms such as coughing, seek medical advice.



If you get toner into your eyes, immediately rinse them with running water for over 15 minutes. Seek medical advice if irritation persists.



If you swallow toner, rinse out your mouth and drink a few glasses of water. Seek medical advice if necessary.



Never touch the electrical contacts of the units (e.g., toner cartridge and developing unit), as an electrostatic discharge may damage the product.



Before handling, see the user documentation for the safety information.



<If instructed to replace the fusing unit>
The fusing section is extremely hot. Before replacing the fusing unit, be sure to open doors and covers of the machine. Then, leave the machine to stand idle for a specified period of time and make sure that the fusing section has cooled down to room temperature. Failure to follow these instructions could result in a burn.



1.4 Regulation notices

CE Marking (Declaration of Conformity) for users of the European Union (EU)

Hereby, Konica Minolta declares that the radio equipment types **bizhub C759/C659, AccurioPrint C759** are in compliance with Directive 2014/53/EU.

The full text of the EU declaration of conformity is available at the following internet address:

"<https://www.konicaminolta.eu/en/business-solutions/support/download-center.html>".

Choose your product and open the section "Safety Documents".

Maximum radio-frequency power transmitted in the frequency band (EIRP):

Module Name, Option	Frequency Band	Radiation Power
UK-215 includes approved Wireless module, MODEL DAUB-KM66:	2.4 GHz	Max. 20 dBm
	5 GHz	Max. 23 dBm
EK-611 includes approved Wireless module, MOD-EL MBH7BLZ02:	2.4 GHz	Max. 3 dBm
AU-201S Authentication Unit:	13.56 MHz	Max. -27 dBm

Note: 5 GHz may not be available

This radio equipment is restricted to indoor use only. Outdoor use is prohibited.

This restriction applies to all the countries listed in the table below.



AT	BE	BG	CH	CY	CZ	DE	DK	EE
EL	ES	FI	FR	HR	HU	IE	IS	IT
LI	LT	LU	LV	MT	NL	NO	PL	PT
RO	SE	SI	SK	TR	UK			

USER INSTRUCTIONS FCC PART 15 - RADIO FREQUENCY DEVICES (for U.S.A. users)

NOTE: This equipment has been tested and found to comply with the limits for a Class A digital device, pursuant to Part 15 of the FCC Rules.

These limits are designed to provide reasonable protection against harmful interference when the equipment is operated in a commercial environment. This equipment generates, uses and can radiate radio frequency energy and, if not installed and used in accordance with the instruction manual, may cause harmful interference to radio communications. Operation of this equipment in a residential area is likely to cause harmful interference in which case the user will be required to correct the interference at his own expense.

⚠ WARNING

- The design and production of this unit conform to FCC regulations, and any changes or modifications must be registered with the FCC and are subject to FCC control. Any changes made by the purchaser or user without first contacting the manufacturer will be subject to penalty under FCC regulations.
- This device must be used with a shielded interface cable. The use of non-shielded cables is likely to result in interference with radio communications and is prohibited under FCC rules.

INTERFERENCE-CAUSING EQUIPMENT STANDARD (ICES-003 ISSUE 5) (for Canada users)

This Class A digital apparatus complies with Canadian ICES-003.

Cet appareil numérique de la classe A est conforme à la norme NMB-003 du Canada.

For users in countries not subject to class B regulations

⚠ WARNING

- This is a Class A product. In a domestic environment this product may cause radio interference in which case the user may be required to take adequate measures.
- This device must be used with a shielded interface cable. The use of non-shielded cables is likely to result in interference with radio communications and is prohibited under CISPR rules and local rules.

GS Certification

This device is not intended for use in the direct field of view at visual display workplaces. To avoid incommuting reflexions at visual display workplaces this device must not be placed in the direct field of view.

Das Gerät ist nicht für die Benutzung im unmittelbaren Gesichtsfeld am Bildschirmarbeitsplatz vorgesehen. Um störende Reflexionen am Bildschirmarbeitsplatz zu vermeiden, darf dieses Produkt nicht im unmittelbaren Gesichtsfeld platziert werden.

Laser safety

This is a digital machine which operates using a laser. There is no possibility of danger from the laser provided the machine is operated according to the instructions in the manuals.

Since radiation emitted by the laser is completely confined within protective housing, the laser beam cannot escape from the machine during any phase of user operation.

This machine is certified as a Class 1 laser product per IEC 60825-1: 2014: This means the machine does not produce hazardous laser radiation.

Internal laser radiation

Maximum Average Radiation Power: 13.3 μW at the laser aperture of the print head unit.

Wavelength: 775-800 nm

This product employs a Class 3B laser diode that emits an invisible laser beam.

The laser diode and the scanning polygon mirror are incorporated in the print head unit.

The print head unit is NOT A FIELD SERVICE ITEM:

Therefore, the print head unit should not be opened under any circumstances.

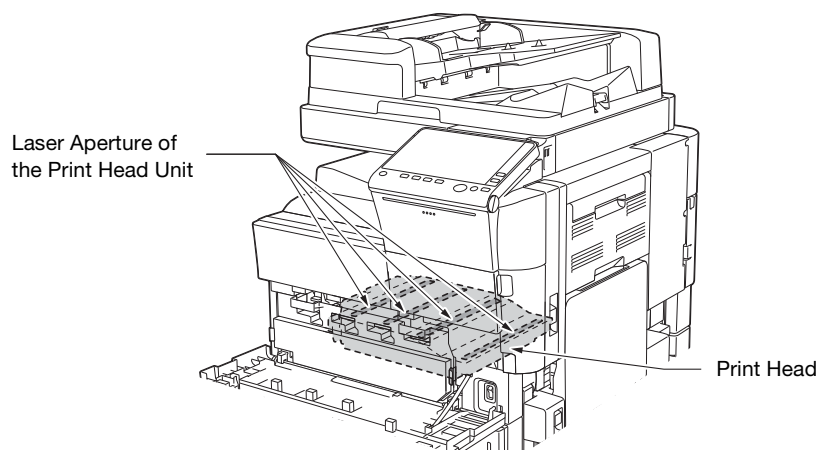

CDRH regulations

This machine is certified as a Class 1 Laser product under Radiation Performance Standard according to the Food, Drug and Cosmetic Act of 1990. Compliance is mandatory for Laser products marketed in the United States and is reported to the Center for Devices and Radiological Health (CDRH) of the U.S. Food and Drug Administration of the U.S. Department of Health and Human Services (DHHS). This means that the device does not produce hazardous laser radiation.

The label shown on page 1-14 indicates compliance with the CDRH regulations and must be attached to laser products marketed in the United States.

⚠ WARNING

Use of controls, adjustments or performance of procedures other than those specified in this manual may result in hazardous radiation exposure.

- This is a semiconductor laser. The maximum power of the laser diode is 30 mW and the wavelength is 775-800 nm.

For European users

⚠ WARNING

Use of controls, adjustments or performance of procedures other than those specified in this manual may result in hazardous radiation exposure.

- This is a semiconductor laser. The maximum power of the laser diode is 30 mW and the wavelength is 775-800 nm.

Laser safety label

A laser safety label is attached to the outside of the machine, as shown below.

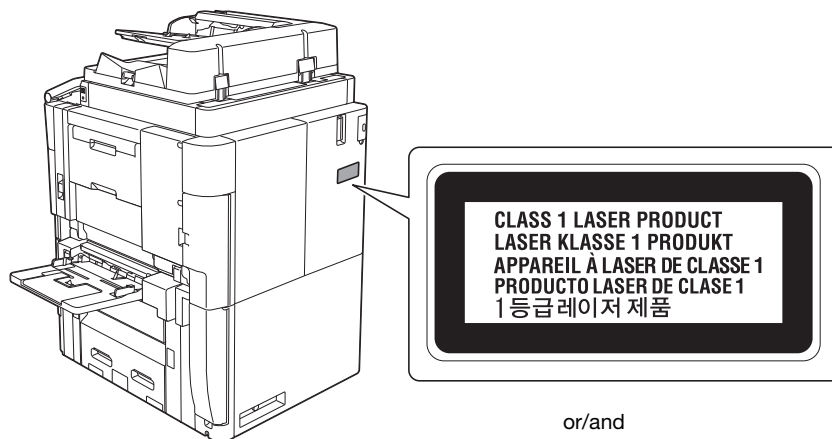

or/and

complies with 21 CFR 1040.10 and 1040.11
 except for deviations pursuant to
 laser notice no. 50, dated June 24, 2007.

Ozone release

Locate the Machine in a Well-Ventilated Room

A negligible amount of ozone is generated during normal operation of this machine. An unpleasant odor may, however, be created in poorly ventilated rooms during extensive machine operations. For a comfortable, healthy and safe operating environment, it is recommended that the room be well ventilated.

Placer l'appareil dans une pièce largement ventilée

Une quantité d'ozone négligable est dégagée pendant le fonctionnement de l'appareil quand celui-ci est utilisé normalement. Cependant, une odeur désagréable peut être ressentie dans les pièces dont l'aération est insuffisante et lorsque une utilisation prolongée de l'appareil est effectuée. Pour avoir la certitude de travailler dans un environnement réunissant des conditions de confort, santé et de sécurité, il est préférable de bien aérer la pièce où se trouve l'appareil.

Acoustic noise (for European users only)

Der höchste Schalldruckpegel beträgt 70 dB(A) oder weniger gemäß EN ISO 7779.

For EU member states only

This symbol means: Do not dispose of this product together with your household waste!

Please refer to the information of your local community or contact our dealers regarding the proper handling of end-of-life electric and electronic equipments. Recycling of this product will help to conserve natural resources and prevent potential negative consequences for the environment and human health caused by inappropriate waste handling.

This product complies with RoHS (2011/65/EU) Directive.

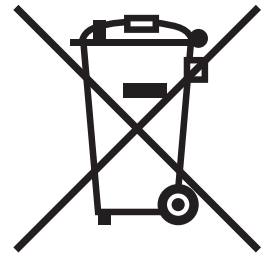

Telephone cable (for users in countries subject to class B regulations)

Connect a telephone cable with a ferrite core to the telecommunication port of this machine. (Connect the modular jack on the ferrite-core-equipped end of the telephone cable to the telecommunication port.)

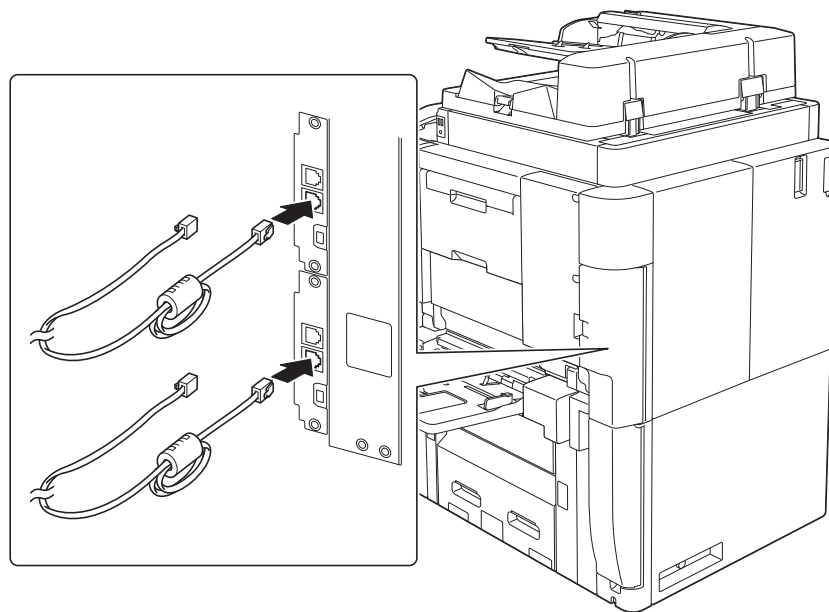















USB Host

Connect USB devices (Memory, Authentication, Hub etc.) devices directly to the USB host. If an extension cable is used, electromagnetic interference could occur.

Graphic symbols used on this machine

These are some of major exemplary graphical symbols.

Graphic symbols	Descriptions	Graphic symbols	Descriptions	Graphic symbols	Descriptions
	"ON" position		"OFF" position		STAND-BY
	push-push type switches		Ground/Earth (Protective bonding terminal)		Ground/Earth (Protective earthing)
	CLASS II EQUIPMENT		Class II equipment with functional earthing		Functional earthing
	General precaution		High temperature		Electrical shock hazard
	CAUTION moving fan blade		CAUTION DOUBLE POLE / NEUTRAL FUSING		

1.5 Caution notations and labels

Safety precaution notations and labels appear on this machine at the following positions. Be very careful that an accident does not occur when operations such as removing paper jams and staple jams are performed.

WARNING
 Do not alter or remove any covers or panels attached to this machine. Some products have a high-voltage part or a laser beam source inside that could cause an electrical shock or blindness.

CAUTION
 It is illegal to reproduce certain types of documents. Do not reproduce such documents.

WARNING
 Do not throw a container that contains toner into an open flame. The hot toner may scatter and cause burns or other damage.

CAUTION
 Do not touch the screws or plate as an electrostatic discharge may damage the product.

CAUTION
 The inside of this product has areas subject to high temperature, which may cause burns. When checking the inside of the unit for malfunctions such as a paper misfeed, do not touch the locations (around the fusing unit, etc.) which are indicated by a "Caution HOT" caution label. A burn could result.

WARNING
 Do not position the used waste-toner box so that it is standing on end or tilted, otherwise toner may spill.

WARNING
 Do not throw a container that contains toner into an open flame. The hot toner may scatter and cause burns or other damage.

WARNING
 CLASS 2 LASER RADIATION WHEN OPEN. AVOID EXPOSURE TO THE BEAM. (English, French, German, Chinese, Korean, Japanese)

CAUTION
 215°C / 419°F

CAUTION
 HOT

NOTICE

Do not remove caution labels or notations. If any caution label or caution notation is soiled, please clean to make legible. If you cannot make them legible, or if the caution label or notation is damaged, please contact your service representative.

1.6 Special notice to user

For Europe

The Facsimile has been confirmed to meet the standards (or requirements) ETSI for pan-European single terminal connection to the public switched telephone network (PSTN).

1.7 Space requirements

To ensure that machine operation, consumables replenishing, part replacement, and regular maintenance can easily be performed, adhere to the recommended space requirements detailed below.

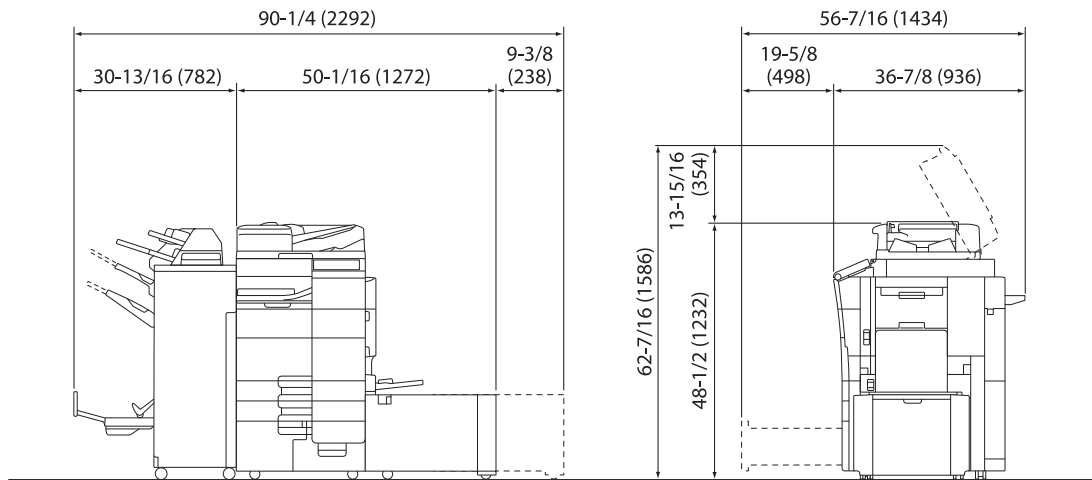

bizhub C759/C659 + FS-537 SD + RU-515 + PI-507 + LU-205
 AccurioPrint C759 + FS-537 SD + RU-515 + PI-507 + LU-205

Unit: inch (mm)

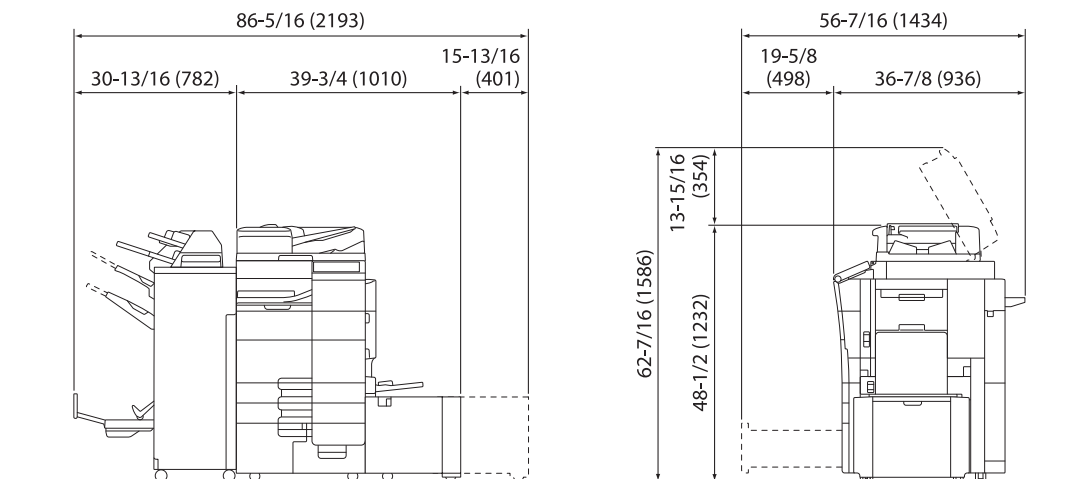

bizhub C759/C659 + FS-537 SD + RU-515 + PI-507 + LU-303
 AccurioPrint C759 + FS-537 SD + RU-515 + PI-507 + LU-303

Unit: inch (mm)

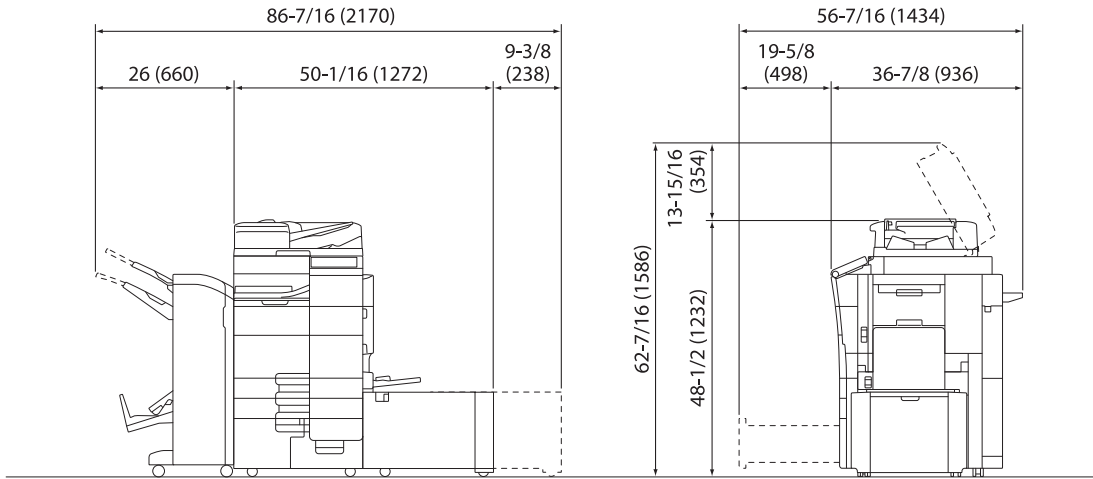

bizhub C759/C659 + FS-536 SD + RU-515 + LU-205
 AccurioPrint C759 + FS-536 SD + RU-515 + LU-205

Unit: inch (mm)

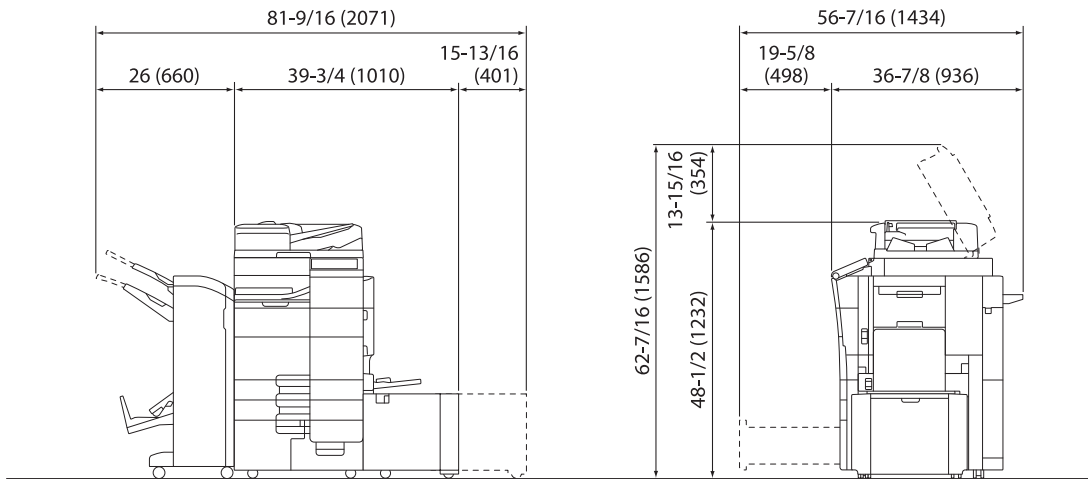

bizhub C759/C659 + FS-536 SD + RU-515 + LU-303
 AccurioPrint C759 + FS-536 SD + RU-515 + LU-303

Unit: inch (mm)

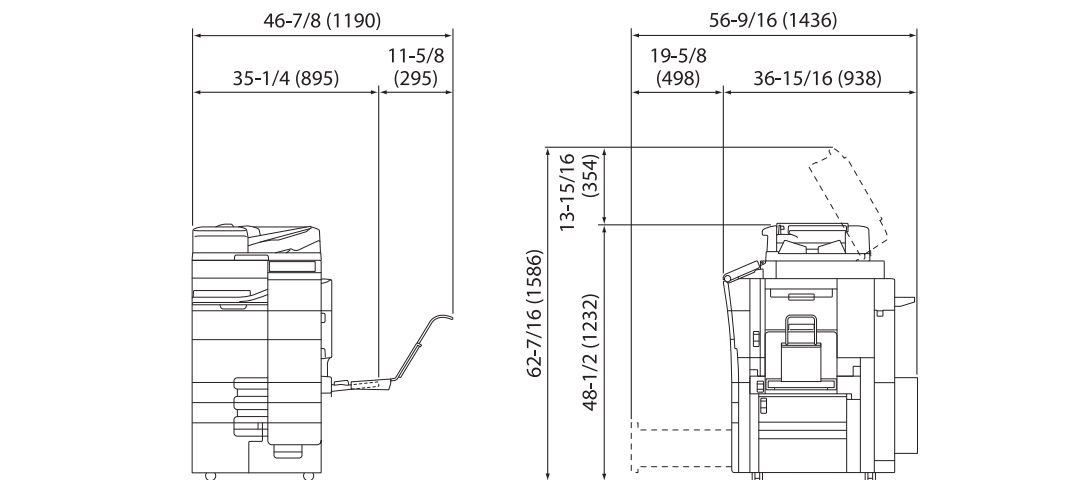

bizhub C759/C659 + MK-715 + CU-102
 AccurioPrint C759 + MK-715 + CU-102

Unit: inch (mm)

NOTICE

Be sure to allow a clearance of 3-15/16 inches (100 mm) or more at the back of this machine for the ventilation duct.

1.8 Operation precautions

To ensure the optimum performance of this machine, observe the precautions described below.

Power source

The power source requirements are as follows.

- Voltage fluctuation: Maximum $\pm 10\%$ (at 110 V/120 V/220 to 240 V AC)
- Frequency fluctuation: Maximum ± 3 Hz (at 50 Hz/60 Hz)
- Use a power source with as little voltage or frequency fluctuations as possible.

Operating environment

The environmental requirements for correct operation of the machine are as follows.

- Temperature: 50°F (10°C) to 86°F (30°C) with fluctuations of no more than 18°F (10°C) within an hour
- Humidity: 15% to 85% with fluctuations of no more than 10% within an hour

Storage of copies

To store copies, follow the recommendation listed below.

- Copies that are to be kept for a long time should be kept where they are not exposed to light in order to prevent them from fading.
- Adhesive that contains solvent (e.g., spray glue) may dissolve the toner on copies.
- Color copies have a thicker layer of toner than normal black-and-white copies. Therefore, when a color copy is folded, the toner at the fold may peel off.

Data stored in this machine

For the machine with hard disk, it is suggested to delete all data stored in all hard disk areas using the overwrite all data function to prevent leakage of data prior to transfer or disposal of the machine, or returning of the leased machine.

For details of the overwrite all data function, refer to the User's Guide. Contact your service representative before deleting data.

It is recommended to backup HDD periodically as the measures for HDD defect. For the detail information of HDD backup, contact your service representative.

1.9 Legal restrictions on reproduction

Certain types of originals must never be reproduced with the purpose or intent to pass reproductions of such originals off as the originals.

The following is not a complete list, but is meant to be used as a guide to responsible reproduction.

<Financial Instruments>

- Personal checks
- Traveler's checks
- Money orders
- Certificates of deposit
- Bonds or other certificates of indebtedness
- Stock certificates

<Legal Originals>

- Food stamps
- Postage stamps (canceled or uncanceled)
- Checks or drafts drawn by government agencies
- Internal revenue stamps (canceled or uncanceled)
- Passports
- Immigration papers
- Motor vehicle licenses and titles
- House and property titles and deeds

<General>

- Identification cards, badges, or insignias
- Copyrighted works without permission of the copyright owner

In addition, it is prohibited under any circumstances to reproduce domestic or foreign currencies, or works of art without permission of the copyright owner.

When in doubt about the nature of an original, consult with legal counsel.

NOTICE

This machine provides the forgery prevention function in order to prevent financial instruments from being reproduced illegally.

We appreciate your understanding that printed images may infrequently have some noise or image data may not be stored under certain circumstances due to this forgery prevention function.

1.10 Trademark acknowledgements

KONICA MINOLTA, the KONICA MINOLTA logo, Giving Shape to Ideas, PageScope, and bizhub are registered trademarks or trademarks of KONICA MINOLTA, INC.

Mozilla and Firefox are trademarks of the Mozilla Foundation.

Microsoft, Windows, Windows 7, Windows 8.1, and Windows 10 are either registered trademarks or trademarks of Microsoft Corporation in the United States and/or other countries.

PowerPC is a trademark of IBM Corporation in the United States, or other countries, or both.

Citrix®, XenApp®, XenDesktop® and XenServer® are registered trademarks of Citrix Systems, Inc. and/or one or more of its subsidiaries, and may be registered in the United States Patent and Trademark Office and in other countries.

Apple, Safari, iPad, iPhone, iPod touch, Macintosh, Mac OS, OS X, macOS and Bonjour are trademarks of Apple Inc., registered in the U.S. and other countries. AirPrint and the AirPrint logo are trademarks of Apple Inc.



CUPS and CUPS logo are trademarks of Apple Inc.

Google, Google Chrome, Android, and Google Cloud Print are registered trademarks or trademarks of Google Inc.

Mopria®, the Mopria® Logo and Mopria® Alliance logo are registered trademarks and service marks of Mopria Alliance, Inc. in the United States and other countries. Unauthorized use is strictly prohibited.

Adobe, the Adobe logo, Acrobat and PostScript are either registered trademarks or trademarks of Adobe Systems Incorporated in the United States and/or other countries.

This [Sublicensee Product] contains Adobe® Reader® LE software under license from Adobe Systems Incorporated, Copyright © 1995-2009 Adobe Systems Incorporated. All rights reserved. Adobe and Reader are trademarks of Adobe Systems Incorporated.

Ethernet is a registered trademark of Xerox Corporation.

PCL is a registered trademark of Hewlett-Packard Company Limited.

This machine and PageScope Box Operator are based in part on the work of the Independent JPEG Group.

Compact-VJE

Copyright 1986-2009 Yahoo Japan Corp.

RC4® is a registered trademark or trademark of EMC Corporation in the United States and/or other countries.

RSA and BSAFE are registered trademarks or trademarks of EMC Corporation in the United States and other countries.



License information

[This product/Product name] includes RSA BSAFE® Cryptographic software from EMC Corporation.

Advanced Wnn

"Advanced Wnn"© OMRON SOFTWARE CO., Ltd. 2006 All Rights Reserved.

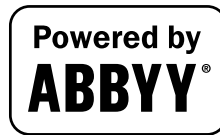

ABBYY and FineReader are registered trade marks of ABBYY Software House.

ThinPrint is a registered trademark or trademark of Cortado AG in Germany and other countries.

QR Code is a registered trademark of DENSO WAVE INCORPORATED.

Wi-Fi, the Wi-Fi CERTIFIED logo, Wi-Fi Alliance, Wi-Fi Direct, Wi-Fi Protected Setup, the Wi-Fi Protected Set-up logo, WPA, and WPA2 are either registered trademarks or trademarks of the Wi-Fi Alliance.



FeliCa is a registered trademark of Sony Corporation.

MIFARE is a registered trademark of NXP Semiconductors.

Bluetooth is a registered trademark of Bluetooth SIG, Inc.

All other product and brand names are trademarks or registered trademarks of their respective companies or organizations.

Copyright

KONICA MINOLTA, INC. maintains the copyright of the printer drivers.

© 2017 KONICA MINOLTA, INC. All Rights Reserved.

Note

User's Guide may not be reproduced in part or in full without permission.

KONICA MINOLTA, INC. will not be held liable for any incidents caused by using this printing system or User's Guide.

Information included in User's Guide is subject to change without notice.

1.11 SOFTWARE LICENSE AGREEMENT

PLEASE READ CAREFULLY THE LICENSE AGREEMENT BELOW BEFORE DOWNLOADING, INSTALLING OR USING THE SOFTWARE. DOWNLOADING, INSTALLING OR USING THE SOFTWARE SHALL BE DEEMED YOUR LAWFUL ACCEPTANCE OF THE TERMS AND CONDITIONS BELOW. IF YOU DO NOT AGREE TO THEM, DO NOT DOWNLOAD, INSTALL, NOR USE THE SOFTWARE.

1. SOFTWARE

"Software" means this computer program (software), independent from its distribution channel, i.e. whether downloaded on royalty-free basis (which may include digitally encoded, machine readable, scalable outline font data as encoded in a special format) or obtained on DVD or any other physical data carrier, together with all codes, techniques, software tools, format, design, concepts, methods and ideas associated with the computer program and all documentation related thereto.

2. COPYRIGHT AND INTELLECTUAL PROPERTY RIGHTS

This is a license agreement and not an agreement for sale. Konica Minolta Business Solutions Europe GmbH ("Konica Minolta") owns, or has been licensed from other owners ("Konica Minolta Licensor"), copyrights and other intellectual property rights of the Software, and any and all rights and title to the Software and any copy made from it are retained by Konica Minolta or Konica Minolta Licensor. In no event, this Agreement shall be deemed to assign any copyright and/or any intellectual property rights of the Software from Konica Minolta or Konica Minolta Licensor to you. Except as stated in this Agreement, you are not granted any rights to patents, copyrights, trade names, trademarks (whether registered or unregistered), or any other rights, franchises or licenses in respect of the Software. The Software is protected by copyright laws and international treaty provisions.

3. LICENSE

Konica Minolta hereby grants to you, and you agree to accept a non-exclusive, non-transferable and limited license, and you may:

- (i) install and use the Software only on your computer(s) connected via inhouse network with a product for which this Software is designed;
- (ii) allow users of the computers described above to use the Software, provided that you assure that all such users comply with the terms of this Agreement;
- (iii) use the Software only for your own customary business or personal purpose;
- (iv) make one copy of the Software only for backup or installation purpose in the support of the normal and intended use of the Software;
- (v) transfer the Software to other party by transferring a copy of this Agreement and all documentation along with the Software, provided that (a) you must, at the same time, either transfer to such other party or destroy all your other copies of the Software, (b) such transfer of possession terminates your license from Konica Minolta, and (c) you must assure that such other party has agreed to accept and be bound by the terms and conditions of this Agreement. If such other party does not accept such terms and conditions then you shall not transfer any copy of the Software.

4. RESTRICTIONS

(1) You must not without the prior written consent of Konica Minolta:

- (i) use, copy, modify, merge or transfer copies of the Software except as provided herein;
- (ii) reverse engineer, reverse assemble, reverse compile or any other way analyze the Software except permitted by law;
- (iii) sublicense, rent, lease or distribute the Software or any copy thereof; or
- (iv) remove, use, or alter any trademark, logo, copyright or other proprietary notices, legends, symbols or labels in the Software.

(2) You agree that you will not export the Software in any form in violation of any applicable laws and regulations regarding export control of any country.

5. LIMITED WARRANTIES

The Software is provided to you "as is" without any warranties whatsoever. The express terms of this Agreement are in lieu of all other warranties, express or implied and Konica Minolta, its affiliate companies and Konica Minolta Licensor disclaim all warranties with regard to the Software, express or implied, including, without limitation, implied warranties of merchantability, fitness for a particular purpose and non-infringement of third party rights. The disclaimer of warranty hereunder does not affect your statutory rights. In case of the disclaimer is not allowed by applicable law, the disclaimer shall only apply to you to the maximum extent permitted by the law.

6. LIMITATION OF REMEDIES

In no event will Konica Minolta, its affiliate companies nor Konica Minolta Licensor be liable for any lost profits, lost data, or any other indirect, special, punitive, incidental or consequential damages that result from use or inability to use the Software, even if Konica Minolta, its affiliate companies, its authorized remarketers or Konica Minolta Licensor have been advised of the possibility of such damages or for any claim by you based on a third party claim.

7. TERMINATION

You may terminate this license at any time by destroying the Software and all your copies of it. This Agreement shall also terminate if you fail to comply with any terms hereof. Upon such termination, you must immediately destroy all copies of the Software in your possession.

8. GOVERNING LAW

This Agreement shall be governed by the laws of the country where the delivery is made to the original customer.

9. SEVERABILITY

In the event that any part or parts of this Agreement shall be held illegal or null and void by any court or administrative body of competent jurisdiction, such determination shall not affect the remaining parts of this Agreement and they shall remain in full force and effect as if such part or parts determined illegal or void had not been included.

10. NOTICE TO US GOVERNMENT END USERS

The Software is a "commercial item," as that term is defined at 48 C.F.R. 2.101 (October 1995), consisting of "commercial computer software" and "commercial computer software documentation," as such terms are used in 48 C.F.R. 12.212 (September 1995). Consistent with 48 C.F.R. 12.212 and 48 C.F.R. 227.7202-1 through 227.7202-4 (June 1995), all U.S. Government End Users shall acquire the Software with only those rights set forth herein.

YOU ACKNOWLEDGE THAT YOU HAVE READ THIS AGREEMENT, UNDERSTAND IT, AND AGREE TO BE BOUND BY ITS TERMS AND CONDITIONS. NEITHER PARTY SHALL BE BOUND BY ANY OTHER STATEMENTS OR REPRESENTATIONS THAT ARE INCONSISTENT WITH THE TERMS AND CONDITIONS OF THIS AGREEMENT. NO AMENDMENT TO THIS AGREEMENT IS EFFECTIVE UNLESS IN WRITING AND SIGNED BY DULY AUTHORIZED REPRESENTATIVES OF EACH PARTY.

1.12 i-Option LK-105 v4 (Searchable PDFs) End User License Agreement

Subject to your purchase of a license key of i-Option LK-105 v4 (searchable PDFs, or "Program"), KONICA MINOLTA, INC. (KM) grants you a non-exclusive and non-transferable sublicense to use the Program provided that you comply with all terms and conditions stated in this Agreement.

1. You agree not to reproduce, modify, or adapt the Program. You may not allow a third party to use the Program or transfer it to a third party.
2. You agree that you will not attempt to alter, disassemble, decrypt, reverse engineer, or decompile the Program.
3. KM or its licensor own the copyright and other intellectual property rights. No copyright or other intellectual property rights shall be transferred to you through the granting of you of a license to use the Program.
4. IN NO EVENT WILL KM OR ITS LICENSOR BE LIABLE TO YOU FOR ANY CONSEQUENTIAL, INCIDENTAL INDIRECT, PUNITIVE OR SPECIAL DAMAGES, INCLUDING ANY LOST PROFITS OR LOST SAVING, EVEN IF KM HAS BEEN ADVISED OF THE POSSIBILITY OF SUCH DAMAGES, OR FOR ANY CLAIM BY ANY THIRD PARTY. KM OR ITS LICENSOR DISCLAIMS ALL WARRANTIES WITH REGARD TO THE PROGRAM, EXPRESS OR IMPLIED, INCLUDING, WITHOUT LIMITATION IMPLIED WARRANTIES OF MERCHANTABILITY, FITNESS FOR A PARTICULAR PURPOSE, TITLE AND NON-INFRINGEMENT OF THIRD PARTY RIGHTS. SOME STATES OR JURISDICTIONS DO NOT ALLOW THE EXCLUSION OR LIMITATION OF INCIDENTAL, CONSEQUENTIAL OR SPECIAL DAMAGES, SO THE ABOVE LIMITATIONS MAY NOT APPLY TO YOU.
5. You agree that you will not export the Program in any form in violation of any applicable laws and regulations regarding export control of any countries.
6. Notice to Government End Users (this provision shall apply to U.S. government end users only) The Program is a "commercial item," as that term is defined at 48 C.F.R.2.101, consisting of "commercial computer software" and "commercial computer software documentation," as such terms are used in 48 C.F.R. 12.212. Consistent with 48 C.F.R. 12.212 and 48 C.F.R. 227.7202-1 through 227.7202-4, all U.S. Government End Users acquire the Program with only those rights set forth herein.
7. This license shall automatically terminate upon a failure on your part to comply with any term or condition of this Agreement, in which case you agree to immediately stop use of the Program.
8. This Agreement shall be governed by the laws of Japan.



About this machine

2 About this machine

2.1 Intended use of office MFP devices

Intended use

This Multi Function Product incorporates the functionality of multiple office devices in one. It is designed to be used as an office system for the following purposes:

- Print, copy, scan and fax documents.
- Use available finishing functions such as duplexing, stapling, hole-punching and booklet creation if appropriate options are installed.
- Store scanned documents on external USB memory devices; send scanned documents to network scan destinations such as FTP, WebDAV and E-mail.

The intended use also requires that:

- The system is used within the limits of device specifications and specifications of optional components,
- All safety instructions in the related user's guides are observed,
- Legal restrictions on reproduction (see page 1-22) are observed,
- Inspection and maintenance instructions are adhered to,
- General, national and company safety provisions are observed.

Impermissible operating conditions

The system may not be operated if:

- Errors or damage have been discovered,
- Maintenance intervals have been exceeded,
- Mechanical or electrical functions do not work as they should.

Exclusion of liability

The manufacturer of the system assumes no liability for damages if the system was operated under impermissible conditions.

2.2 Introduction to user's guide

The user's guide of this product consists of the [Quick Guide] and the User's Guide CD/DVD.

The [Quick Guide] describes basic machine procedures.

If you want to learn about more detailed functions or operation methods, refer to the User's Guide included in the User's Guide CD/DVD.

In addition, you can access [Frequently Asked Questions] on the top page (home) of the relevant file on the User's Guide CD/DVD for detailed information on "Frequently Asked Questions" and "Troubleshooting".

2.2.1 [Quick Guide] (this manual)

This manual describes basic procedures users will need to know in order to use this machine, as well as setting procedures. It also introduces major functions, and basic troubleshooting procedures to make use of this machine more conveniently.

This manual also contains notes and precautions that should be followed in order to use this machine. Please be sure to read this manual before using this machine.

2.2.2 User's Guide CD/DVD

The User's Guide CD/DVD is provided with this machine.

This CD/DVD contains basic and detailed information on the functions of this product and also explanations of other various setting functions.

Select a desired function on the top page (Home), and check the details of the function.

Selecting [Introduction] on the top page (Home) allows you to view detailed methods for using the User's Guide.

Layout of top page



No.	Name	Description
1	[Search by Function]	Searches for desired information based on functions such as printing or scanning, and based on buttons displayed on the Touch Panel .
2	[Search]	Enter one or multiple keywords to search within the User's Guide. If necessary, you can distinguish between upper and lower case alphabet characters to carry out a search. (Some pages are not targeted for searching.)
3	[Search by Usage]	Searches for the required operations of this machine based on a request "to do something". This function also provides security measures against various situations and methods to realize cost reductions.

No.	Name	Description
4	[Search by Illustration]	Searches for the required operations of this machine based on the output results, functions, and operation images.

Operating environment

Item	Specifications
Supported operating systems	Windows 7 (SP1), Windows 8.1, Windows 10 Mac OS 10.8/10.9/10.10/10.11/10.12
Supported Web browsers	Windows: Microsoft Internet Explorer 9.x/10.x (Desktop version)/11.x (Desktop version), Microsoft Edge, Firefox 20 or later, Google Chrome 26 or later Mac OS: Safari 6.0.3 to 10.x <ul style="list-style-type: none"> We recommend that you use the latest Web browser that is compatible with your operating system to help you use this machine more conveniently and comfortably. Check that JavaScript in your Web browser is enabled. The User's Guide uses JavaScript for the page display and search functions.
Display resolution	1024 × 768 pixels or more

2.2.3 Target groups

The user's guides (see page 2-4) are intended for the following users of the system:

Target group	Description
User	Persons using the system for its intended use (see page 2-3) as well as managing system functions and consumables according to the assigned user rights.
Administrator	Persons managing consumables, system functions, users and access rights; adjusting system settings, and establishing network connections.

Everyone who uses this system must have read and understood the related user's guides.

2.2.4 Symbols and notations used in this manual

Procedural instruction

- ✓ This check mark symbol shows a precondition of a procedure.
- 1 This format number "1" represents the first step.
- 2 This format number represents the order of serial steps.
 - This symbol indicates a supplementary explanation of a procedural instruction.

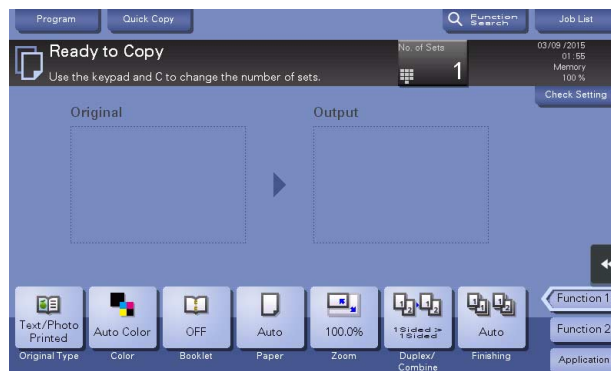

Symbols and notations

WARNING

- Improper handling can cause serious injury or death.

CAUTION

- Improper handling can cause minor injury or damage to houses and property.

NOTICE

This symbol indicates a risk that may result in damage to this machine or documents. Follow the instructions to avoid property damage.



Tips

- This symbol indicates supplemental information of a topic as well as options required to use a function.



Reference

This symbol indicates reference functions related to a topic.



Related setting

This shows the settings related to a particular topic for any user.



Related setting (for the administrator)

This shows the settings related to a topic only for administrators.

Symbols/Notations	Description
✓	This check mark symbol shows a precondition of a procedure.
→	This symbol indicates a supplementary explanation of a procedural instruction.
[]	An item enclosed by brackets [] indicates a key name on the Touch Panel or computer screen, or the name of a user's guide.
Bold text	This presents a key name, part name, product name, or option name on the Control Panel .

Screens

Some of the screen displays for this machine vary depending on whether the fax function is available.

This manual describes procedures using the screen displays when the fax function is available. When the fax function is not available, change "Scan/Fax" to "SCAN" to read a description.

Names and notations of applications

This manual uses a notation for each application name as shown below.

Name	Notations used in this manual
PageScope Web Connection	Web Connection
PageScope My Panel Manager	My Panel Manager

2.3 About this machine

2.3.1 Optional components

Various optional components can be added to meet your office requirements.

List of optional components

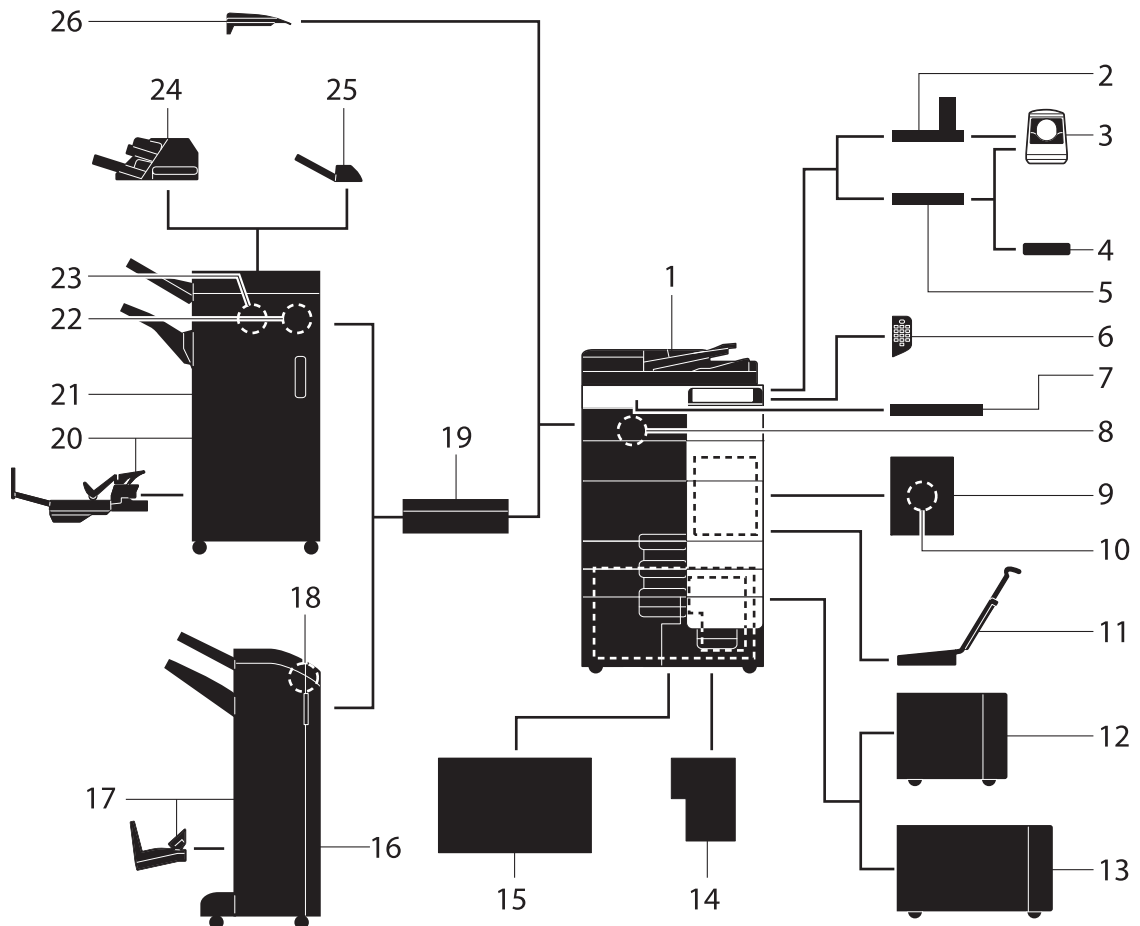

No.	Name	Description
1	Main unit	Scans the original in the scanner section, and prints a scanned image in the printer section.
2	Working Table WT-513	This is used to move the Control Panel . This is also used when the Authentication Unit AU-102 is installed.
3	Authentication Unit AU-102	Performs user authentication by scanning vein patterns in the finger. The Working Table WT-506 or Working Table WT-513 is required to install the Authentication Unit AU-102 .
4	Authentication Unit AU-201S	Performs user authentication by scanning information recorded on the IC card or NFC-compatible Android terminal. The Mount Kit MK-735 is required to install the Authentication Unit AU-201S . This unit can also be installed on the Working Table WT-506 .
5	Working Table WT-506	Provides an area to temporarily place an original or other materials. This is also used when the Authentication Unit AU-102 or Authentication Unit AU-201S is installed.
6	Keypad KP-101	It is equipped on the side of the Control Panel . Allows you to enter numbers by using the Hardware Keypad.

No.	Name	Description
7	Keyboard Holder KH-102	Install this holder to use a external keyboard. For details on external keyboards, contact your service representative.
8	Fax Kit FK-516	Used to operate this machine as a fax machine. Alternatively, this kit allows more telephone lines to be connected.
9	Fax Mount Kit MK-742	This unit is required to install FAX Kit FK-515 . This option can be used in North America.
10	FAX Kit FK-515	Used to add telephone lines. Fax Mount Kit MK-742 is required to install FAX Kit FK-515 . This option can be used in North America.
11	Mount Kit MK-715	Used to print data on banner paper.
12	Large Capacity Unit LU-303	Allows you to load up to 3000 sheets of 8-1/2 × 11 (A4) size.
13	Large Capacity Unit LU-205	Allows you to load up to 2500 sheets of SRA3 or 11 × 17 (A3) size.
14	Image Controller IC-418	Provides the high-quality printing result. Video Interface Kit VI-510 is required to install Image Controller IC-418 .
15	Clean Unit CU-102	Collects small particles (UFP) generated in this machine to prevent them from escaping this machine.
16	Finisher FS-536	Sorts, groups and staples printed paper before outputting it. To install the Finisher FS-536 , the Relay Unit RU-515 is required.
17	Finisher FS-536 SD	Sorts, groups, staples, folds, and binds printed paper before outputting it. To install the Finisher FS-536 SD , the Relay Unit RU-515 is required. The Finisher FS-536 contains the Saddle Stitcher .
18	Punch Kit PK-520	Install this unit onto the Finisher FS-536/FS-536 SD . This unit supports the punching function.
19	Relay Unit RU-515	This unit is required to install the Finisher FS-537/FS-537 SD/FS-536/FS-536 SD on this machine.
20	Finisher FS-537 SD	Sorts, groups, staples, folds, and binds printed paper before outputting it. To install the Finisher FS-537 SD , the Relay Unit RU-515 is required. The Finisher FS-537 contains the Saddle Stitcher .
21	Finisher FS-537	Sorts, groups and staples printed paper before outputting it. To install the Finisher FS-537 , the Relay Unit RU-515 is required.
22	Punch Kit PK-523	Install this unit onto the Finisher FS-537/FS-537 SD . This unit supports the punching function.
23	Z Folding Unit ZU-609	Install this unit onto the Finisher FS-537/FS-537 SD . This unit supports the Z-fold function.
24	Post Inserter PI-507	Install this unit onto the Finisher FS-537/FS-537 SD . This unit allows you to insert cover sheets into the copied or printed sheets. This unit also allows you to manually operate the finisher (only the lower tray is available).
25	Job Separator JS-602	Install this unit onto the Finisher FS-537/FS-537 SD . This unit sorts printed sheets.
26	Output Tray OT-508	Outputs printed pages.

List of other optional components

The following options are built into this machine and are not shown in the figure.

No.	Name	Description
1	Stamp Unit SP-501	Stamps a scanned original when sending a fax. This unit allows you to check that the original has been scanned.
2	Spare TX Marker Stamp 2	A replacement stamp for the Stamp Unit SP-501 .
3	Local Interface Kit EK-611	Install this unit when using the connection function with a Bluetooth LE-compatible iOS terminal. The USB port, and receiving device for Bluetooth LE communication are added. For details on the association with an iOS terminal, refer to the User's Guide CD/DVD.
4	Video Interface Kit VI-510	This unit is required to install Image Controller IC-418 .
5	Security Kit SC-508	Supports the copy guard and password copy functions to prevent unauthorized copying.
6	i-Option LK-102 v3	Supports the PDF processing function that is one of the advanced functions.
7	i-Option LK-105 v4	Supports the searchable PDF function that is one of the advanced functions.
8	i-Option LK-106	Used to add a bar code font that is one of special fonts.
9	i-Option LK-107	Used to add a unicode font that is one of special fonts.
10	i-Option LK-108	Used to add an OCR font that is one of special fonts. In the standard, the OCR-B font (PostScript) is available. Installing the i-Option LK-108 allows use of the OCR-A font (PCL).
11	i-Option LK-110 v2	Used to add an advanced function that converts a file into the DOCX or XLSX type or generates highly-functional and high-quality data. i-Option LK-110 v2 includes the function licenses for i-Option LK-102 v3 and LK-105 v4 . If you purchase i-Option LK-110 v2 , you do not need to purchase i-Option LK-102 v3 or LK-105 v4 . For details about functions able to be added, refer to the User's Guide CD/DVD.
12	i-Option LK-111	Supports the ThinPrint function that is one of the advanced functions.
13	i-Option LK-114	Supports the serverless pull printing function that is one of the advanced functions.
14	i-Option LK-115 v2	You can use TPM (Trusted Platform Module) that is one of the advanced functions. Security enhancement is realized by encrypting confidential information such as certificates and passwords of this machine.
15	Upgrade Kit UK-212	Allows you to use this machine in a wireless network environment.
16	Upgrade Kit UK-215	Allows you to use this machine in a wireless network environment. The Upgrade Kit UK-215 is only available in some areas.
17	Double feed detection Kit UK-501	This unit allows you to detect that pages of the original are multiplexed on the ADF .
18	Mount Kit MK-735	Required to have Authentication Unit AU-201S built in to the main unit.
19	Heater HT-508	Prevents paper in a paper tray from being affected by humidity. The Heater HT-508 is installed as standard in some areas.
20	Hard Disk HD-524	Install this unit to perform mirroring of the hard disk contained in the main unit.

2.3.2 Name of parts (MFP)

Front

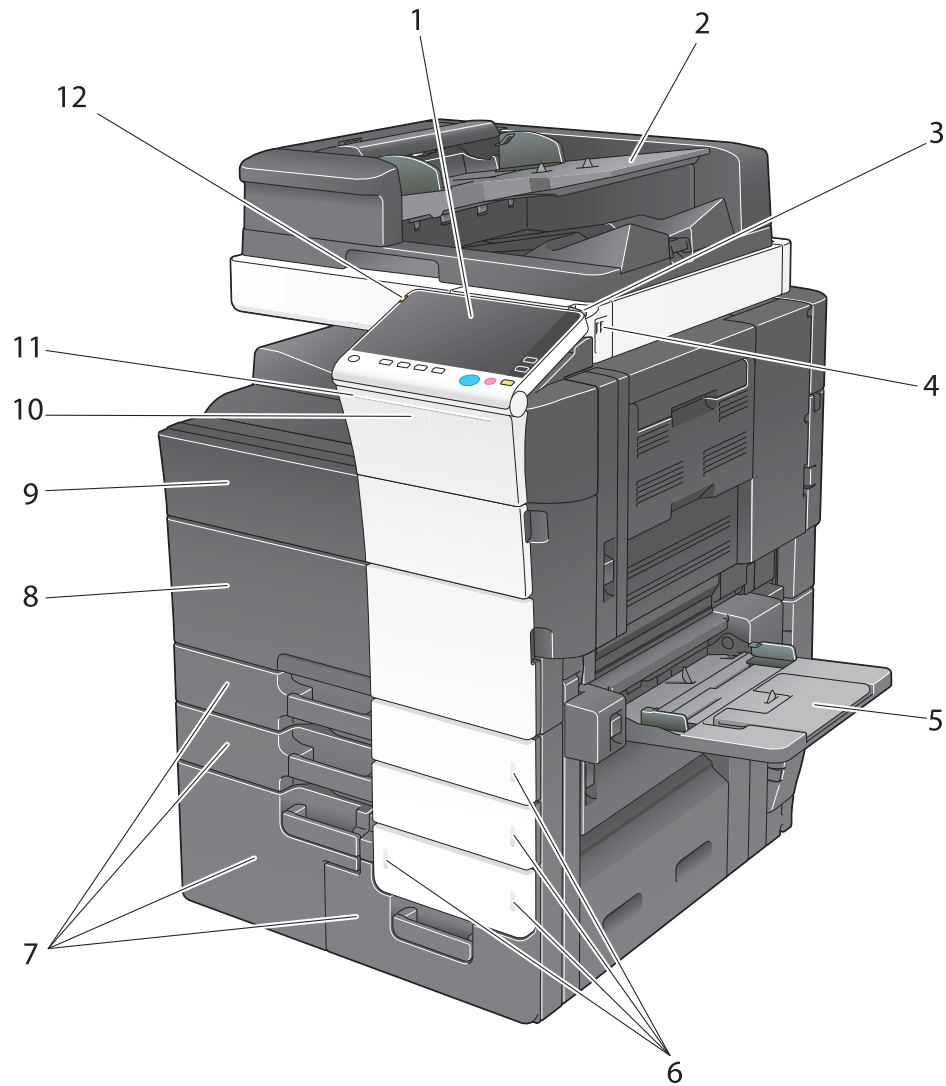

No.	Name	Description
1	Control Panel	Use the Touch Panel or buttons on this panel to operate this machine.
2	Original Tray	Load the original.
3	Stylus Pen	Used to operate the Touch Panel .
4	USB Port (Type A) USB2.0/1.1	Used to connect an external memory unit (USB memory unit) to this machine.
5	Bypass Tray	Used to load custom-size paper or special paper.
6	Paper-Empty Indicator	Flashes orange when a tray runs low on paper and lights up orange when the tray runs out of paper.
7	Paper Tray	Used to load standard-size paper.
8	Lower Front Door	Open this door to replace consumables or to maintenance this machine.
9	Upper Front Door	Open this door to replace a Toner Cartridge .
10	Data Indicator	Flashes blue while this machine is receiving a job. If a job is currently spooled, this indicator lamp lights up blue.

No.	Name	Description
11	Status Indicator	Flashes white during printing.
12	Warning Indicator	Flashes orange if a warning occurs. Lights up orange if this machine has stopped due to an error.

Side/rear

The illustration shows the main unit that is equipped with the optional **Fax Kit FK-516**, **FAX Kit FK-515**, and **Fax Mount Kit MK-742**.

(**FAX Kit FK-515** and **Fax Mount Kit MK-742** can be used in North America.)

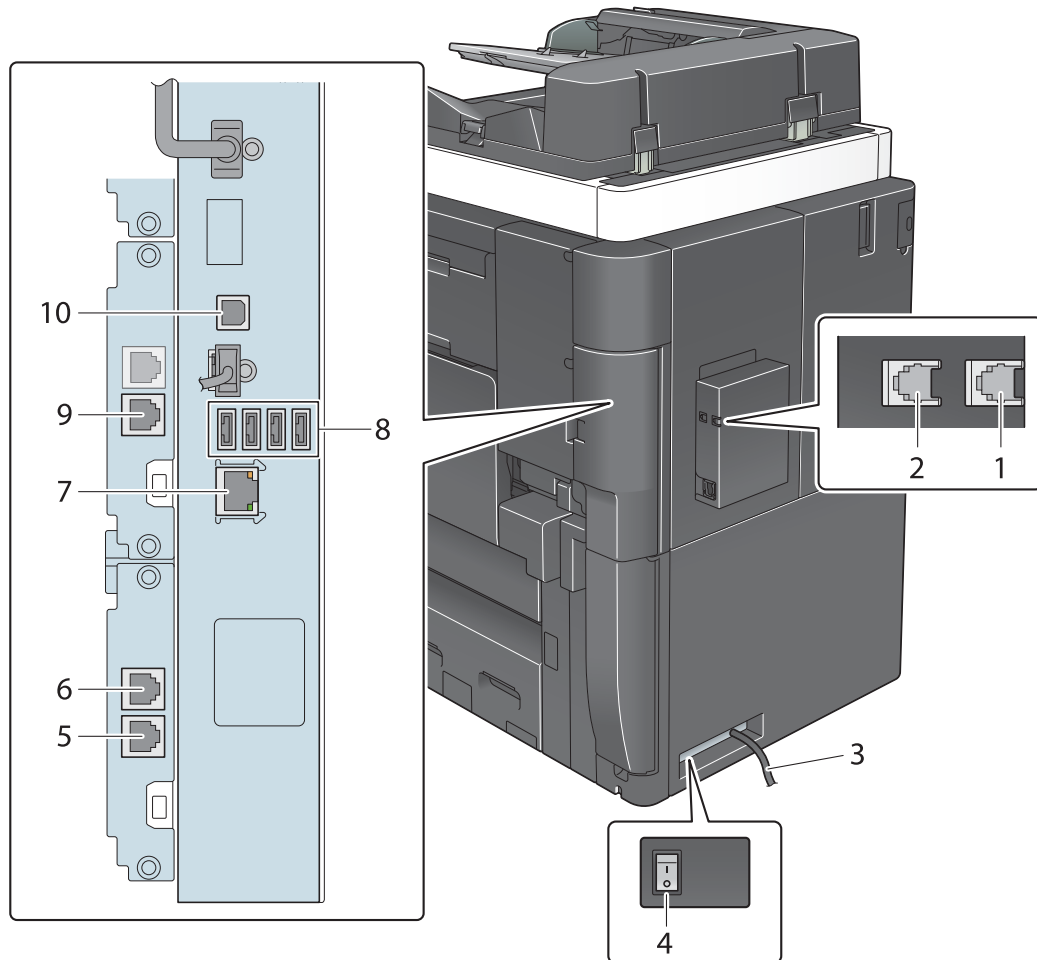

No.	Name
1	Telephone Jack 4 (LINE PORT4)
2	Telephone Jack 3 (LINE PORT3)
3	Power Cord
4	Heater Power Switch
5	Telephone Jack 1 (LINE PORT1)
6	Jack for connecting a telephone (TEL PORT1)
7	Network Connector (10Base-T/100Base-TX/1000Base-T)
8	USB Port (Type A) USB2.0/1.1
9	Telephone Jack 2 (LINE PORT2)
10	USB Port (Type B) USB2.0/1.1

Tips

- The network port of this product is following No.7 and No.10. A port is activated when a network port inserts a cable.



Reference

For details, refer to the User's Guide CD/DVD.

2.3.3 Name of parts (Optional units)

This section shows the names of distinctive parts for each optional unit that can be installed in this machine.

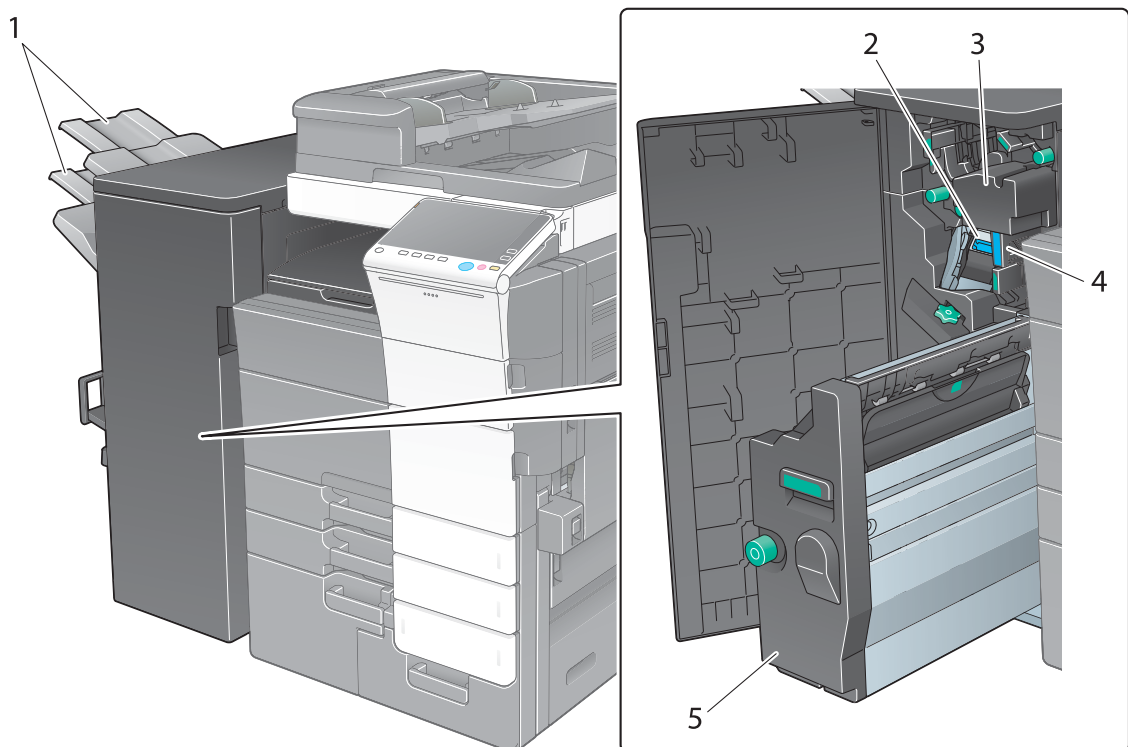
Finisher FS-537/Finisher FS-537 SD/Punch Kit PK-523/Z Folding Unit ZU-609



No.	Name
1	Output Tray
2	Staple Cartridge
3	Punch Kit
4	Punch Scrap Box
5	Saddle Stitcher

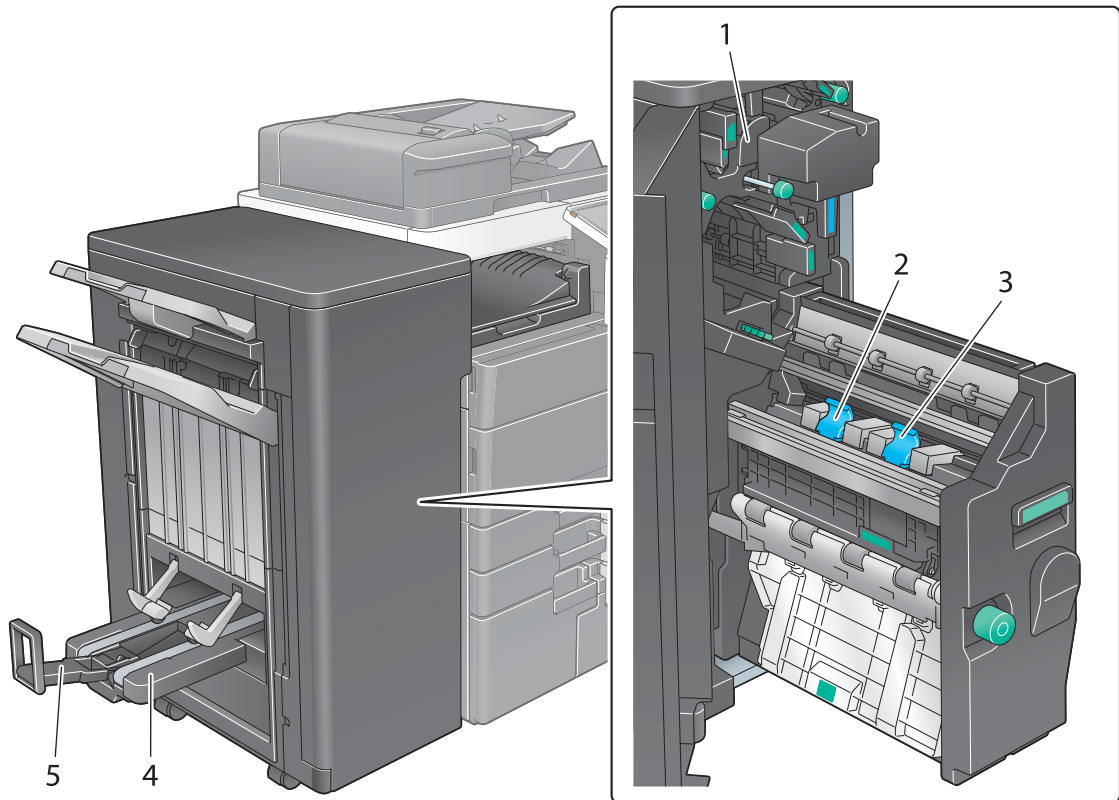

No.	Name
1	Z Folding Unit
2	Saddle Staple Cartridge 1
3	Saddle Staple Cartridge 2
4	Folding Output Tray
5	Stopper

Job Separator JS-602

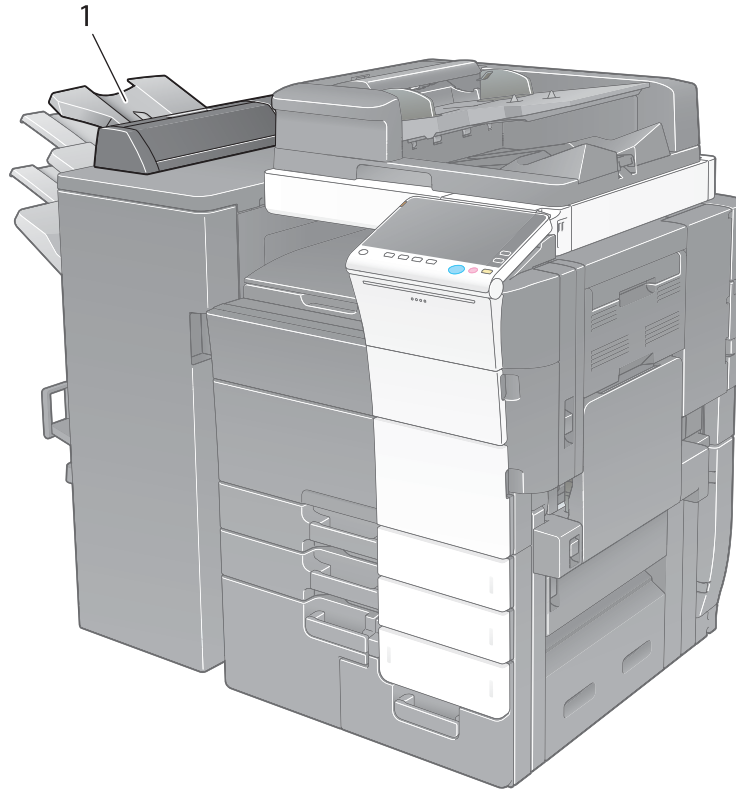

No.	Name
1	Output Tray

Post Inserter PI-507

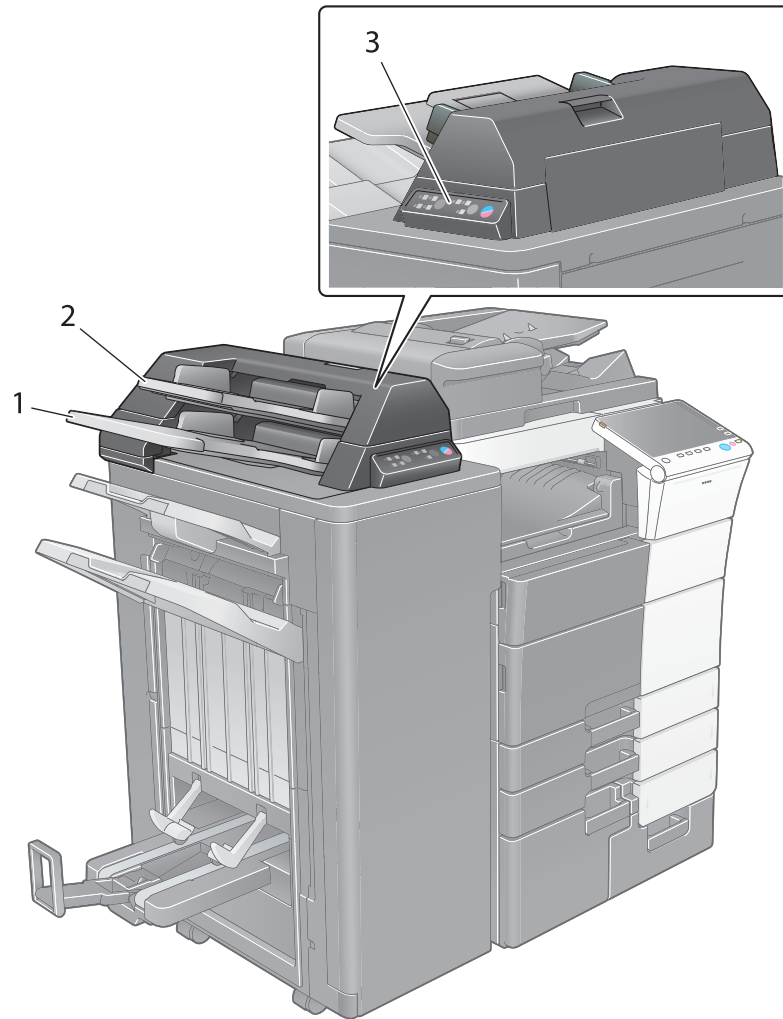

No.	Name
1	Lower Tray
2	Upper Tray
3	Post Inserter Control Panel



Reference

For details on how to use the **Post Inserter Control Panel**, refer to the *User's Guide CD/DVD*.

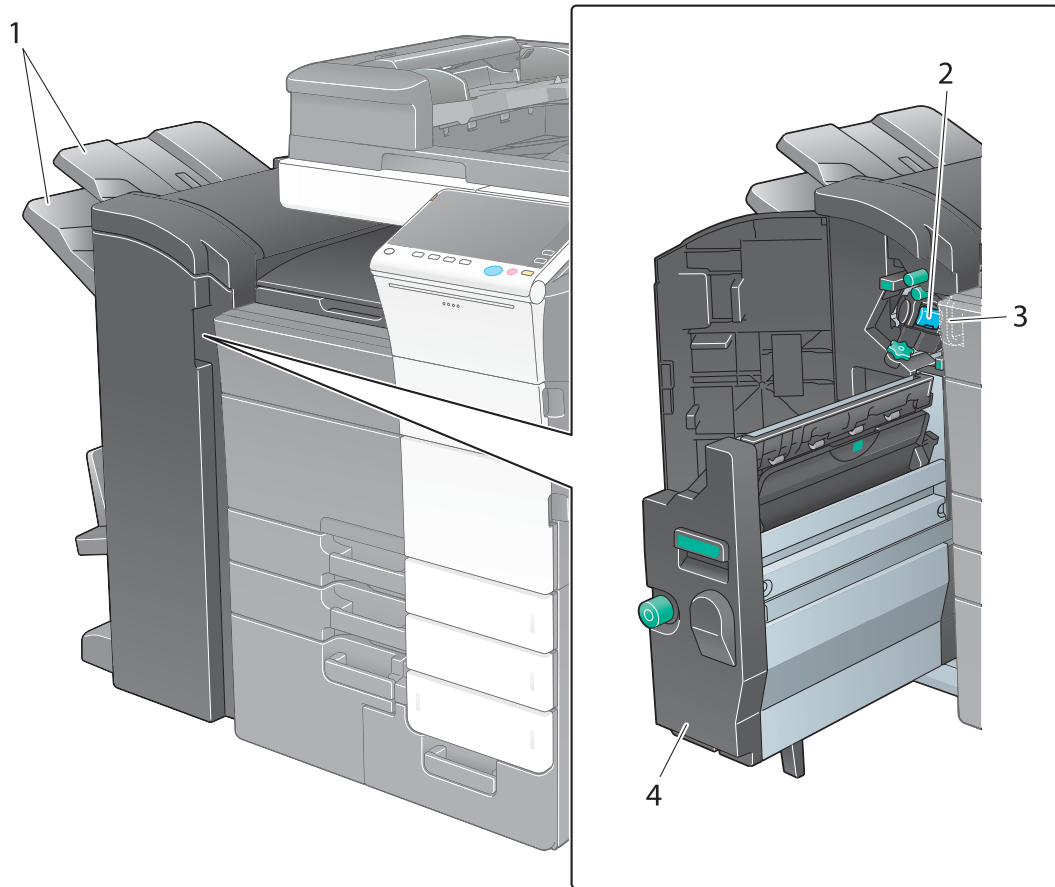
Finisher FS-536/Finisher FS-536 SD/Punch Kit PK-520

No.	Name
1	Output Tray
2	Staple Cartridge
3	Punch Scrap Box
4	Saddle Sticher

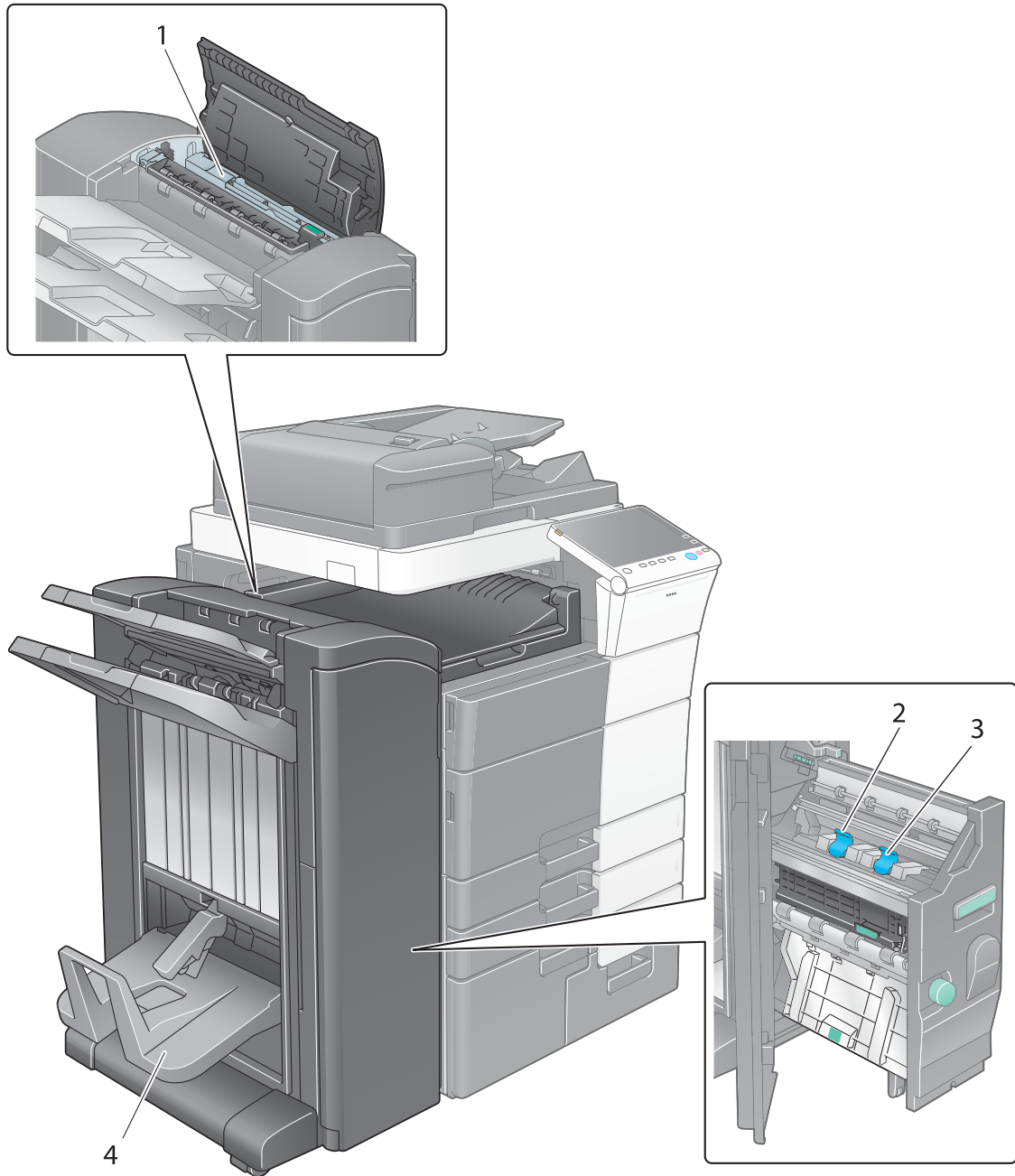

No.	Name
1	Punch Kit
2	Saddle Staple Cartridge 1
3	Saddle Staple Cartridge 2
4	Folding Output Tray

Large Capacity Unit LU-303/LU-205

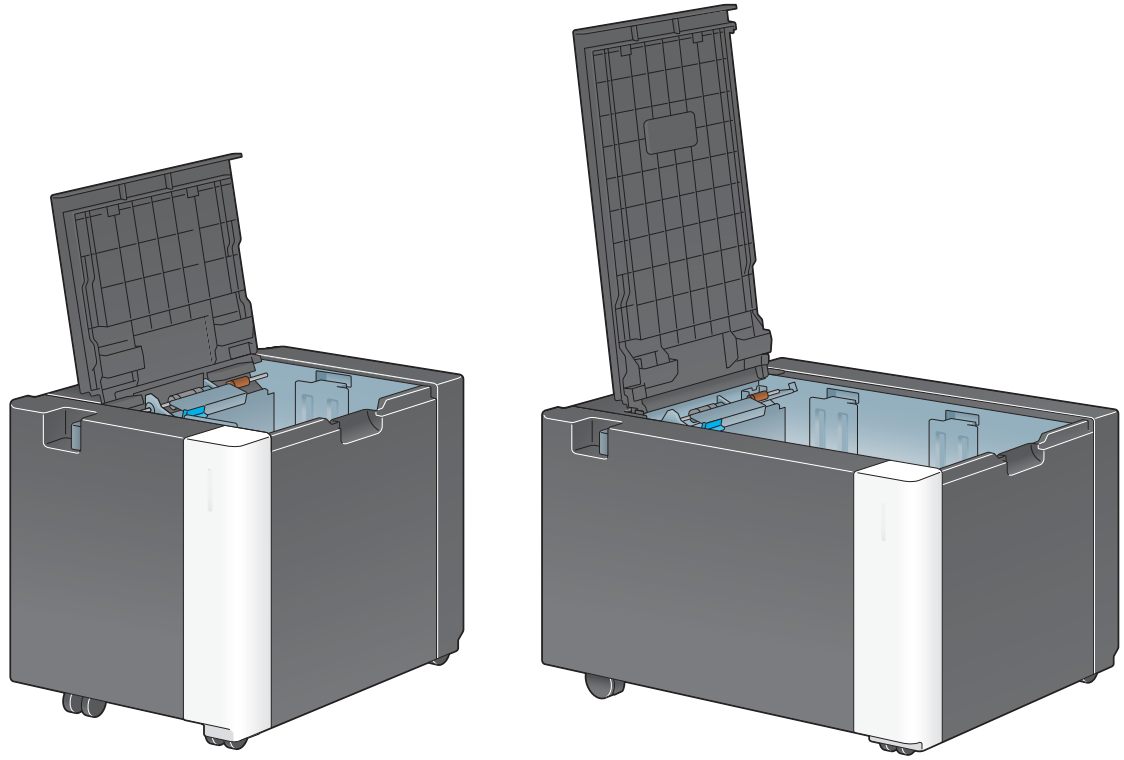

2.4 Power supply

This machine provides two power switches: **Power** key on the **Control Panel** and **Main Power Switch** on the machine. Under normal conditions, operate the **Power** key of the **Control Panel**. Use **Main Power Switch** to restart this machine.

2.4.1 Turning the power on and off

Turn the power on and off only when necessary, for example, when the administrative settings are changed or a power failure occurs.

- 1 Open the **Lower Front Door**, and press | on the **Main Power Switch**.

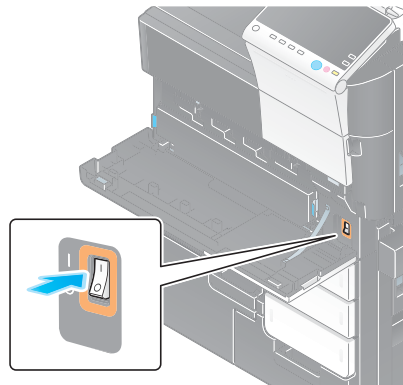

- 2 Press ○ on the **Main Power Switch**.

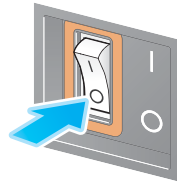

NOTICE

*When restarting this machine, turn the **Main Power Switch** off and on again after 10 or more seconds have passed.*

2.4.2 Operating the Power key

To immediately shift to the power save mode, for example, when work is finished or when not operating this machine for a long period of time, press the **Power** key.

Depending on how long the **Power** key is pressed, the state of the power save mode to be activated will differ.

Pressing the **Power** key briefly during operation shifts to the low power or sleep mode. Holding down the Power key shifts to the Sub Power OFF mode.

To return this machine from the power save mode to the normal mode, press the **Power** key again.

In the low power or sleep mode, you can return this machine from the power save mode to the normal mode simply by placing your hand close to the **Control Panel**.

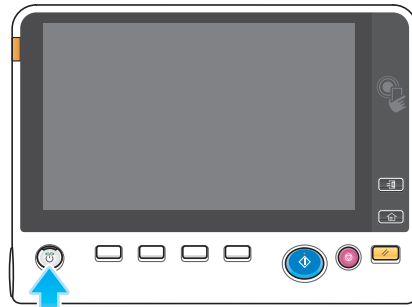

Status of this machine		Description
Power Save mode	Low Power or Sleep mode	Flashes blue. This machine returns to the normal mode when data or faxes are received.
	Sub Power OFF mode	Lights up orange. This machine can receive data or faxes, but cannot scan or print an original. If data or faxes are received when the machine is in the Sub Power OFF mode, they are printed when the machine returns to the normal mode.
Normal mode	During operation	Lights up blue.

Tips

- When the optional **Image Controller** is installed, the machine cannot shift to the Sub Power OFF mode.

2.4.3 Power save function

If the specified time elapses after the machine becomes inactive, the machine automatically shifts to the power save mode; for example, the **Touch Panel** display is turned off. The **Power** key flashes blue in the power save mode. The power save mode returns to the normal mode by pressing any key on the **Control Panel** for instance.

There are two power save modes: the low power mode and the sleep mode. Sleep mode provides a greater power saving effect than Low Power mode. However, the time required to return to Normal mode is longer than the time required to revert to Low Power mode.



Reference

The time required to shift to each mode can be changed in the Administrator Settings. For details, refer to the User's Guide CD/DVD.

Reducing power consumption

To reduce power consumption in the standby state, change [Power Key Setting] to [Sub Power OFF].

Tap [Utility], and select [Administrator Settings] - [System Settings] - [Power Supply/Power Save Settings] - [Power Key Setting].

For information on the default administrator password, refer to the User's Guide CD/DVD.

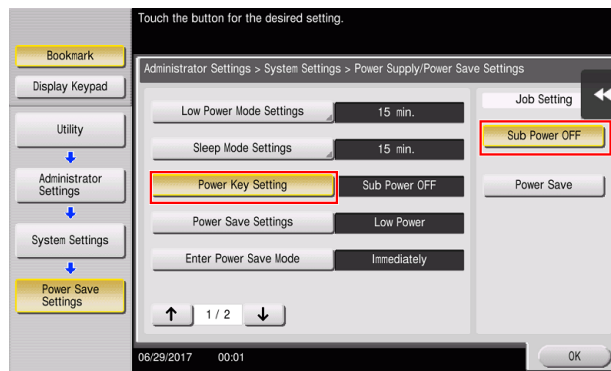

After the setting is changed, the power save mode shifts as shown below depending on how the **Power** key is pressed.

- Pressing the **Power** key
 - This machine shifts to the Sub Power OFF mode.
 - In the Sub Power OFF mode, the machine can receive data or faxes, but cannot scan or print an original.
 - If data or faxes are received when the machine is in the Sub Power OFF mode, they are printed when the machine returns to the normal mode.
- Holding down the **Power** key
 - This machine shifts to the ErP Auto Power OFF mode.
 - In the ErP Auto Power OFF mode, this machine cannot receive data or faxes and also cannot scan or print an original.
 - This function provides a greater power saving effect than the sub power off mode, which is close to the state where the main power is turned off.

To enable the machine to return to the normal mode from the Sub Power OFF or ErP Auto Power OFF mode, press the **Power** key again.



Tips

- When the optional **Image Controller** is installed, [Power Key Setting] is not displayed.



Reference

For details, refer to the User's Guide CD/DVD.

2.5 Control Panel

The optional **Keypad KP-101** is equipped on the right side of the **Control Panel**.

2.5.1 Name of parts

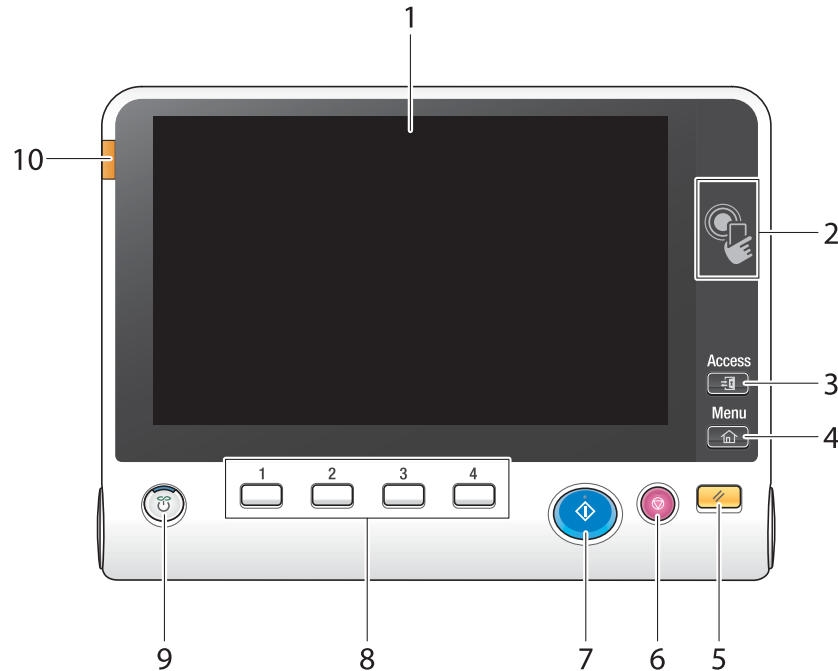

No.	Name	Description
1	Touch Panel	Displays setting screens and messages. Directly press this panel to carry out operations.
2	Mobile touch area	Used to associate this machine with an NFC-compatible Android terminal. You can place an Android terminal with PageScope Mobile for Android installed on the mobile touch area to register this machine or to perform user authentication. This area is also used to associate this machine with an iOS terminal that supports Bluetooth LE. The optional Local Interface Kit EK-611 is required to use the Bluetooth LE function. Bringing the iOS terminal closer to this machine allows you to register this machine or perform user authentication with an operation from PageScope Mobile for iPhone/iPad . For details, refer to the User's Guide CD/DVD.
3	Access	If user authentication or account track is enabled, enter the user name and password for user authentication or the account name and password for account track, then press this key to start the use of this machine. After a target operation is completed, press this key once again to end the use of this machine.
4	Menu	Press this key to display the Main Menu.
5	Reset	Press this key to reset the settings you entered or changed on the Control Panel .
6	Stop	Press this key to temporarily stop an active copy, scan, or print job.
7	Start	Press this key to start an operation such as copying, scanning, faxing, or printing.

No.	Name	Description
8	1 - 4	<p>Press each key to switch the display of the Touch Panel to a function assigned to a Register key.</p> <ul style="list-style-type: none"> • 1 ([Enlarge Display]): Enters Enlarge Display mode. • 2 ([Guidance]): Press this key to display the Help Menu. You can display descriptions of the functions and operating procedures on the screen. • 3 ([10 Keypad]): Displays the Keypad on the Touch Panel. • 4 ([Preview]): Press this key to display a finishing image with the current settings on the Touch Panel. This function can also print a single proof copy to be checked before printing a large number of copies. <p>These keys can be assigned to any function in the Administrator Settings to be easy to use.</p>
9	Power	<p>Press this key to switch this machine to the Power Save mode. In the normal mode, the key lights up blue. In the power save mode, the key blinks blue or lights up orange.</p> <p>To create a higher power saving effect, you can change the setting in [Power Key Setting] of Administrator Settings. For [Power Key Setting], refer to page 2-21.</p>
10	Warning Indicator	<p>Flashes orange if a warning occurs. Lights up orange if this machine has stopped due to an error.</p>

Equipped with the optional **Keypad KP-101**

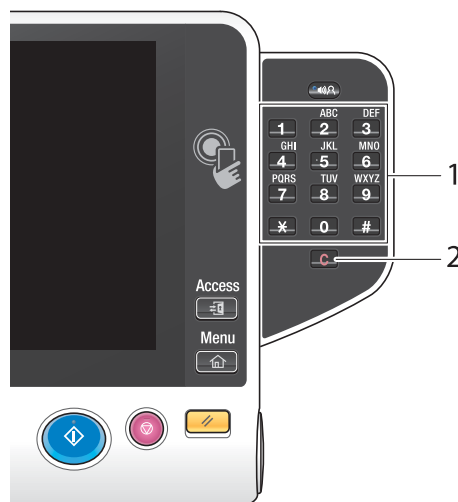

No.	Name	Description
1	Keypad	Use this keypad to enter numeric values such as the number of copies, zoom ratio, and fax number.
2	C (Clear)	All the numeric values(number of pages, magnification, size, etc), which have been entered by Keypad , are canceled.

2.6 Touch Panel

2.6.1 Main Menu

Press the **Menu** key on the **Control Panel** to display the main menu. In the main menu, you can configure settings such as frequently used functions or a shortcut key for jumping to each mode.

Layout of main menu



No.	Name	Description
1	[Accessibility]	Tap this button to adjust a Touch Panel tapping position, change keying sounds, and configure the operating environment of the Control Panel .
	[Counter]	Tap this button to display the total number of pages printed on this machine on a function or color basis.
	User/Account Name	This area displays the name of the current login user or the account track name when User Authentication or Account Track is enabled. When User Authentication and Account Track are used together, the user name is displayed.
	[Language]	Tap this button to temporarily change the language to be displayed on the panel. For details on how to display [Language], refer to the User's Guide CD/DVD.
	[Function Search]	Tap this button to search for copy settings or fax/scan settings to go to the target function screen from the search result.
	[Job List]	Tap this button to display current or standby jobs. If necessary, you can check job logs or print a communication report. This list displays the operation status of the current job when it is running. For details, refer to page 2-32.
2	Page Indicator	Allows you to check which page is currently displayed when main menu keys are assigned to multiple pages.
3	Main menu keys	Display shortcut keys assigned to any function. By default, [Copy], [Scan/Fax], [User Box], [Sound Setting], [Address book], and [Utility] are arranged on the main menu. <ul style="list-style-type: none"> In some areas, [Quick Security] is located on the main menu by default.
	[Utility]	Tap this button to configure settings of this machine or check the use status of this machine. <ul style="list-style-type: none"> [Utility] is always displayed.
4	Page switching key	Tap this key to switch pages when main menu keys are assigned to multiple pages.

Customizing the main menu

The main menu can be extended to three screens as necessary. Up to 25 keys can be assigned to three main menu screens which can be switched.

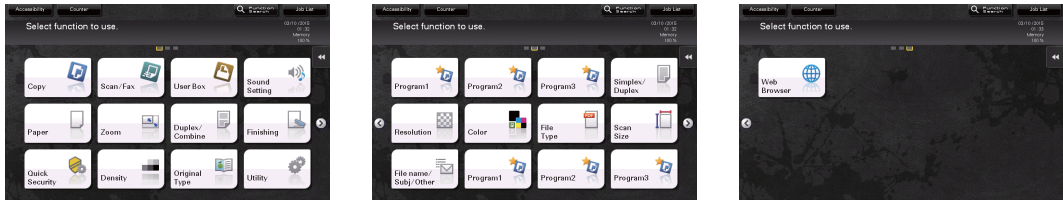

In addition, you can specify your favorite background pattern. If necessary, you can add a background pattern by registering an image on this machine.

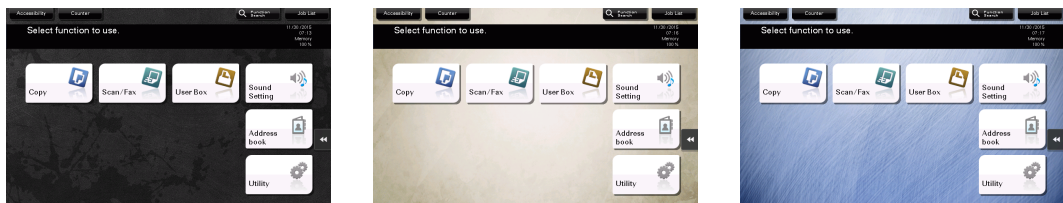

 **Reference**

For details, refer to the User's Guide CD/DVD.

2.6.2 Slide menu

Tapping a tab key on the **Touch Panel** slides open the menu. The setting of the slide menu can be changed to suit your environment.

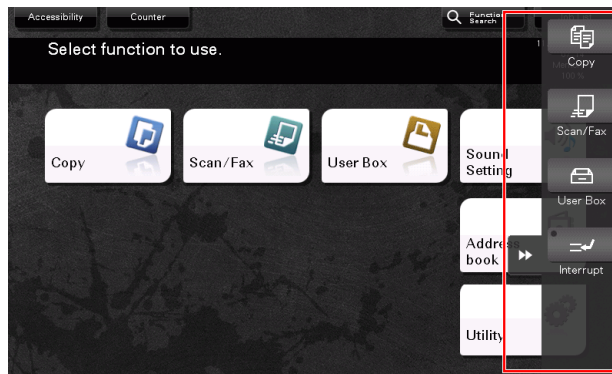

Name	Description
Tab key	Tap this key to open and close the slide menu.
Slide menu key	Display function keys assigned to any function. By default, the main menu shows [Copy], [Scan/Fax], [User Box], and [Interrupt].

Customizing the slide menu

Up to five slide menus can be set.

You can configure the setting to prevent the slide menu. Also, you can display the **Keypad** or change the background color.

 **Reference**

For details, refer to the User's Guide CD/DVD.

2.6.3 Operating the Touch Panel

The Touch Panel of this machine supports user-friendly operations, such as, sliding a finger on the **Touch Panel**.

Tap

Lightly touch the screen with your finger, then remove your finger from the screen immediately. This action is available when selecting or determining a menu.



Double-tap

Lightly touch the screen with your finger twice in succession. Used to retrieve detailed information, to enlarge a thumbnail or preview image, and to open a User Box.

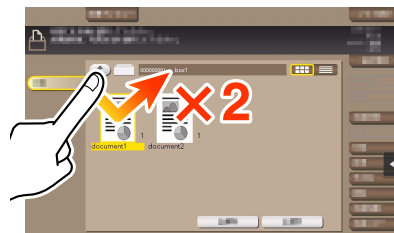

Flick

Make a slight flip while sliding your finger on the screen. Used to scroll the destination/job list or to feed a page in the Main menu screen/Preview screen.

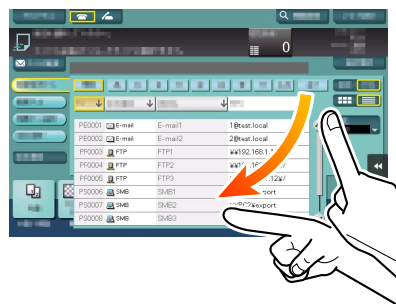

Drag

To move the scroll bar or document, place your finger on it and move your finger. Used to move the scroll bar or document.

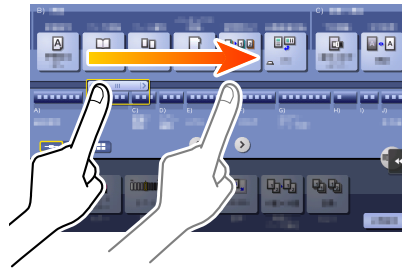

Pan

Slide your finger parallel in a front-to-back and side-to-side direction on the screen. Used to move to the intended display location if data spans multiple screens.

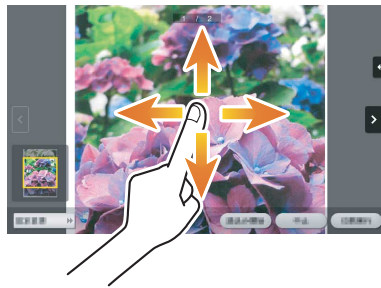

Long-tap

Hold down the document by the finger. Used to display the icon related to the document.



Drag & Drop

Slide your finger to the intended place and release it while a document is selected. Used to move the document to the intended place.

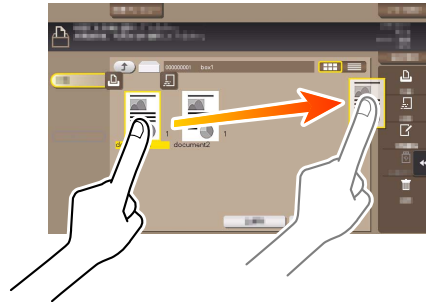

Pinch-in / Pinch-out

Place two fingers on the screen and then open or close them. Used to enlarge or reduce a preview image.



Rotation

Place two fingers on the screen and then rotate them. Used to rotate a preview image.



Precautions for using the Touch Panel

This machine features a capacitance-base touch panel. Note the following points when operating the **Touch Panel**.

- Use your finger or the **Stylus Pen** supplied with this machine. Note that the **Touch Panel** will not respond appropriately if you operate it using your nail or a pen tip instead of your finger or the **Stylus Pen**.
- Applying a strong force to the **Touch Panel** will damages the **Touch Panel**, and potentially cause a breakage.
- When operating the **Touch Panel**, do not press on it using excessive force or with a pointed object such as a mechanical pencil.
- Be careful not to operate **Touch Panel** with wet fingers. It may cause **Touch Panel** to be improperly operated.
- If you operate the **Touch Panel** with a gloved finger, the **Touch Panel** will not respond normally. You should operate it with a bare finger or using the **Stylus Pen** supplied with this machine.
- Note that the **Touch Panel** may not respond normally if the distance between the user and fluorescent light is 19-11/16 inches (500 mm) or less when you operate the **Touch Panel**.
- You must not use the Touch Panel near equipment that generates electrical noises such as an electric generator or air conditioner. Otherwise a malfunction may be caused by an influence of electrical noises.

2.6.4 How to display the Keypad

When tapping the input area on the copy screen and etc. for entering the number of copies or entering adjustment values, the **Keypad** will be displayed.

It can also be displayed by pressing the **10 Keypad** key (default: Register key **3**).

Input area for entering the number of copies

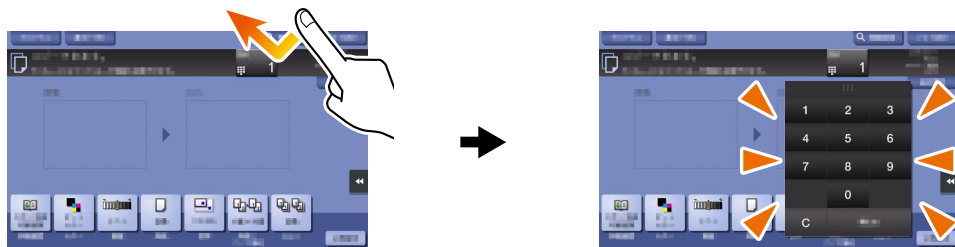

Input area for entering values

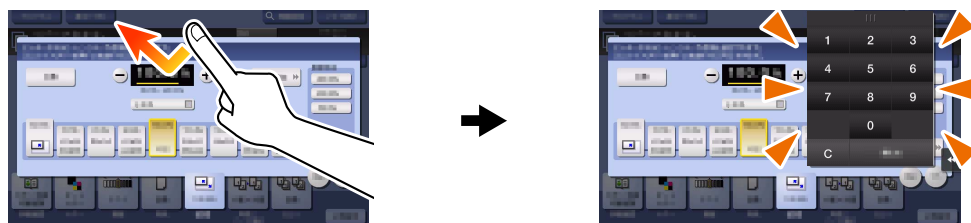

How to move the Keypad

Move your finger while the upper side of **Keypad** is being pressed.



How to close the Keypad

After entering, tap [Close] to close the **Keypad**.

It can also be closed by pressing the **10 Keypad** key (default: Register key **3**).



To display the Keypad all the time

The **Keypad** can always be displayed to enable entry of the number of copies on the copy screen, User Box print setting screen, or browser print setting screen.



Reference

For details, refer to the User's Guide CD/DVD.

2.6.5 Entering characters

When entering characters to register an address or program, use the keyboard screen displayed on the Touch Panel.

When typing in "Group1":

- 1 To type in uppercase letters or symbols, tap the [Shift] key.
 - If you mistyped, tap [←] or [→] to move the cursor to the character you want to clear, then tap the [Delete] key.
 - Tap the [Shift] key again to return to the original keyboard screen.

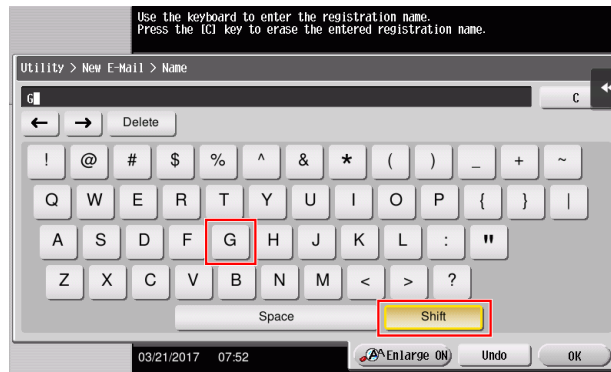

- 2 After typing completes, tap [OK].

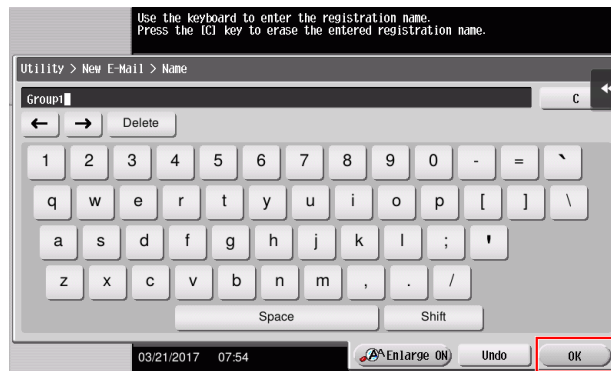

2.7 Jobs

2.7.1 Job screen

A job refers to an individual operation unit such as printing, sending, receiving, or saving.

When you tap [Job List] in the main menu or the main screen of each mode, the Job screen appears.

In the Job screen, you can view a list or history of a job currently being executed or print a sending-receiving result report.

In general, jobs are executed starting from the job at the top of the list of currently active jobs. If you are in a hurry to execute any particular jobs, you can rearrange the job execution order.

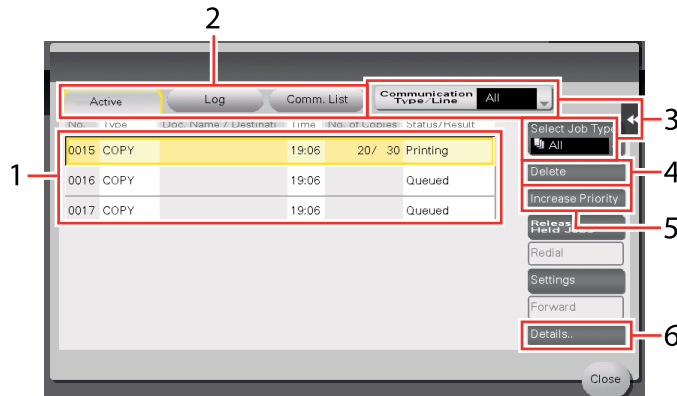

No.	Description
1	Displays jobs.
2	Select a job type. In [Comm. List], you can also print a sending-receiving result report.
3	Tap this button to narrow down the jobs to be displayed.
4	Tap this button to delete a job.
5	Tap this button to select a job to be executed preferentially.
6	Tap this button to view details of a selected job.



Reference

For details, refer to the User's Guide CD/DVD.

2.7.2 Multi-job function

While a job is active, you can register another job. Up to 259 jobs can be registered in total.

The table below shows the maximum number of jobs that can be registered for each function.

Function	Minimum number of jobs	Maximum number of jobs
Copy	6	62
Print	11	67
Fax memory TX + Scan	55	111
Fax RX	100	156
Sharing	56	-

These values may vary depending on conditions.

2.8 Loading Paper













2.8.1 Loading paper in Tray 1 to Tray 2

Up to 500 sheets of plain paper can be loaded into each tray.

Applicable paper types

Plain paper, single-side-only paper, thin paper, special paper, thick paper, letterhead, colored paper, and recycled paper

Applicable paper sizes

Type	Size
Standard-size paper	12 × 18  , 12-1/4 × 18  , 11 × 17  to 5-1/2 × 8-1/2  , SRA3  , A3  to A5  , B4  , B5   , 8 × 13  , 16K  , 8K 
Custom-size paper	Width: 5-1/2 to 12-5/8 inches (139.7 mm to 320 mm) Length: 7-3/16 to 18 inches (182 mm to 457.2 mm)

How to load paper

- 1 Pull out the tray.

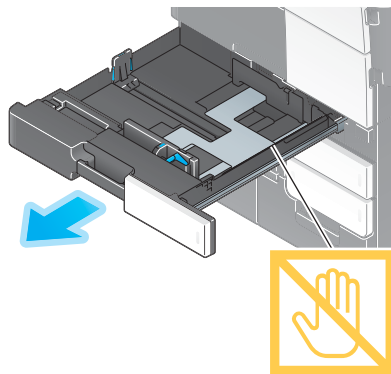

NOTICE

Be careful not to touch the **Film**.

- 2 Slide the **Lateral Guide** to fit the size of the loaded paper.

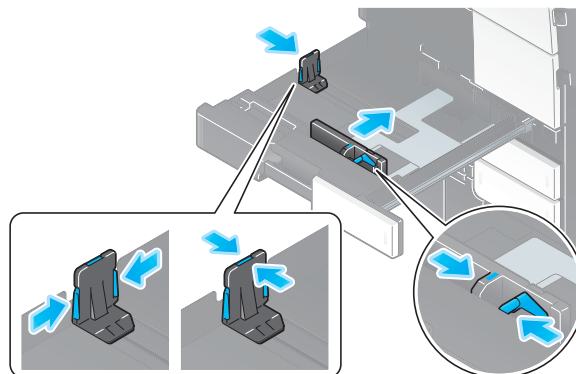

- 3 Load paper into the tray with the print side facing up.

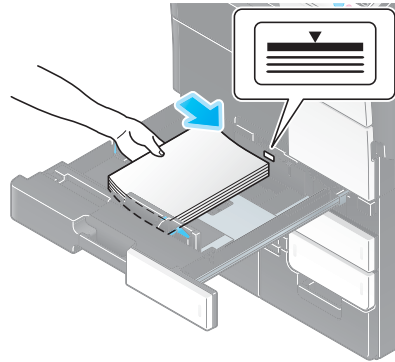

- 4 Close the Tray.

When you change the paper type or change to custom size paper, proceed to step 5 to change the setting on this machine.

When you do not change the paper type or change to custom size paper when adding paper, you can use the current setting without making any changes.

- 5 Change the paper type and paper size settings.

- When loading paper other than plain paper, change the paper type setting.
- When loading custom sized paper, change the paper type setting.
- For details, refer to the User's Guide CD/DVD.

2.8.2 Loading paper in Tray 3 to Tray 4









Up to 1500 sheets of plain paper can be loaded into **Tray 3**, and up to 1000 sheets of plain paper can be loaded into **Tray 4**. It will be convenient to load the most frequently used paper.

Up to 200 postcards can be loaded into the tray.

Applicable paper types

Plain paper, single-side-only paper, thin paper, special paper, thick paper, letterhead, colored paper, recycled paper, and postcard (4 × 6 (A6 Card))

Applicable paper sizes

Type	Size
Standard-size paper	8-1/2 × 11  , 5-1/2 × 8-1/2  , 4 × 6  , A4  , A5  , B5  , A6 Card  , 16K 

How to load paper

- 1 Pull out the tray.

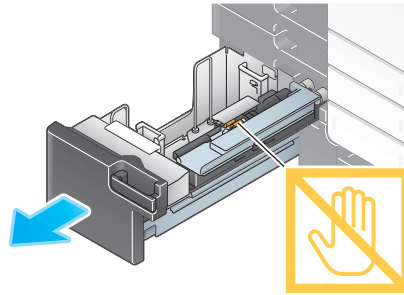

NOTICE

Be careful not to touch the surface of the **Paper Feed Rollers** with your hand.

- 2 Load the paper with the required side facing upward.

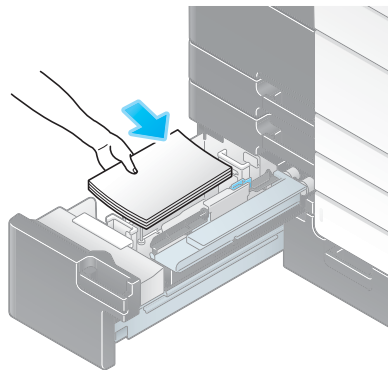

NOTICE

Do not load the tray with paper of a size other than that previously specified. When changing the paper size, contact your service representative.

- 3 Close the Tray.
When you change the paper type, proceed to step 4 to change the setting on this machine.
When you do not change the paper type when adding paper, you can use the current setting without making any changes.
- 4 Change the paper type setting.
→ When loading paper other than plain paper, change the paper type setting. For details, refer to the User's Guide CD/DVD.

2.8.3 Loading paper into the Large Capacity Unit

Up to 3000 sheets of plain paper can be loaded into **Large Capacity Unit LU-303**, and up to 2500 sheets of plain paper into **Large Capacity Unit LU-205**. The **Large Capacity Unit** is an option.

Applicable paper types









Plain paper, single-side-only paper, thin paper, special paper, thick paper, letterhead, colored paper, recycled paper

Applicable paper sizes

Large Capacity Unit LU-303

Type	Size
Standard-size paper	8-1/2 × 11  , A4 

Large Capacity Unit LU-205

Type	Size
Standard-size paper	12 × 18  , 11 × 17  to 8-1/2 × 11   , SRA3  , A3  , B4  , A4  

How to load paper

- 1 Open the **Upper Door**.

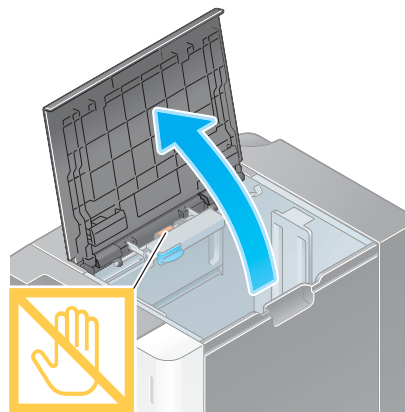

NOTICE

Be careful not to touch the surface of the **Paper Feed Rollers** with your hand.

- 2 Lift the **Paper Feed Rollers**, and load the paper with the required side facing downward.

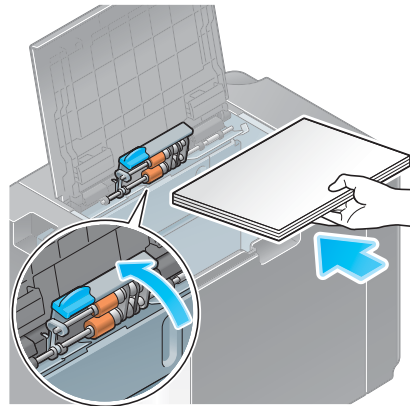

NOTICE

Do not load custom sized paper into the **Large Capacity Unit**. When changing the paper size, contact your service representative.

- 3 Close the **Upper Door**.

When you change the paper type, proceed to step 4 to change the setting on this machine. When you do not change the paper type when adding paper, you can use the current setting without making any changes.

- 4 Change the paper type setting.

→ When loading paper other than plain paper, change the paper type setting. For details, refer to the User's Guide CD/DVD.

2.8.4 Bypass Tray

When selecting a paper size other than for paper trays or printing on envelopes or transparencies, use the **Bypass Tray**.

To use the **Bypass Tray**, load paper and specify the paper type.

Applicable paper types

Plain paper, single-side-only paper, thin paper, special paper, thick paper, postcard (4 × 6 (A6 Card)), transparency, letterhead, colored paper, envelope, label sheets, index paper, recycled paper, and banner paper

Applicable paper sizes

Type	Size
Standard-size paper	12 × 18 to 5-1/2 × 8-1/2 , 4 × 6 , SRA3 , A3 to A6 , B4 to B6 , A6 card , 8 × 13 , 16K , 8K , banner paper, envelope (B5 (6-15/16 inches × 9-13/16 inches (176 mm × 250 mm)), C4 (9 inches × 12-3/4 inches (229 mm × 324 mm)), C5 (6-3/8 inches × 9 inches (162 mm × 229 mm)), C6 (6-3/8 inches × 4-1/2 inches (162 mm × 114 mm)), DL (8-11/16 inches × 4-5/16 inches (220 mm × 110 mm)), Com10 (4-1/8 inches × 9-1/2 inches (104.7 mm × 241.3 mm)), Monarch (3-7/8 inches × 7-1/2 inches (98.4 mm × 190.5 mm)))
Custom-size paper	Paper width: 3-9/16 inches to 12-5/8 inches (90 mm to 320 mm) Paper length: 5-1/2 inches to 47-1/4 inches (139.7 mm to 1,200 mm)

Paper not available

Do not load the following paper into the **Bypass Tray**. Doing so may cause a paper jam or damage to the machine.

- Folded, torn or creased paper, or bundles of sheets of different sizes

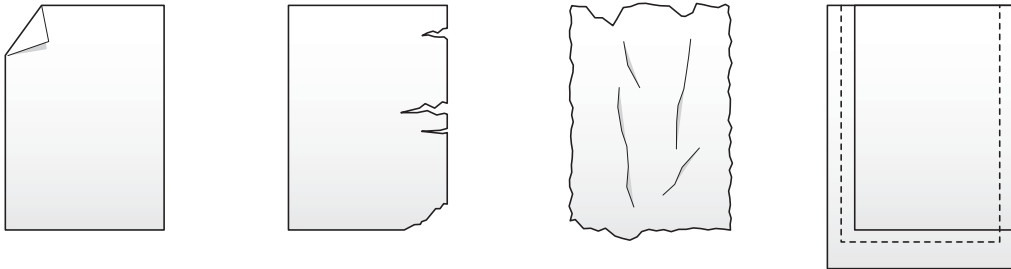

How to load paper

- 1 Open the **Bypass Tray**.

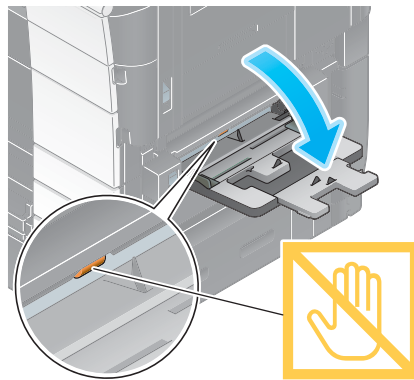

→ To load large-sized paper, pull out the **Tray Extension**.

→ To load banner paper, install the optional **Mount Kit MK-715**.

NOTICE

*Be careful not to touch the surface of the **Paper Feed Rollers** with your hand.*

- 2 Load paper with the print side facing down, then align the **Lateral Guide** to the paper.
 - Insert paper into the tray until their edges are pressed against the back.

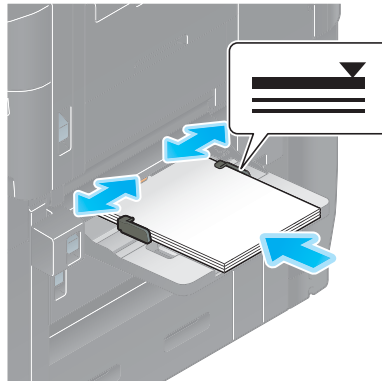

NOTICE

Do not load an excessive number of sheets such that the top of the stack is higher than the ▼ mark.

If paper is curled, flatten it before loading it.

When you change the paper type or change to custom size paper, proceed to step 3 to change the setting on this machine.

When you do not change the paper type or change to custom size paper when adding paper, you can use the current setting without making any changes.

- 3 Change the paper type and paper size settings.
 - When loading paper other than plain paper, change the paper type setting.
 - When loading custom sized paper, change the paper type setting.
 - For details, refer to the User's Guide CD/DVD.

Loading postcards

Up to 50 postcards can be loaded into the tray.

- 1 Load postcards in the □ direction as shown in the figure with the print side facing down, then align the **Lateral Guide** to the paper.
 - Insert postcards into the tray until their edges are pressed against the back.

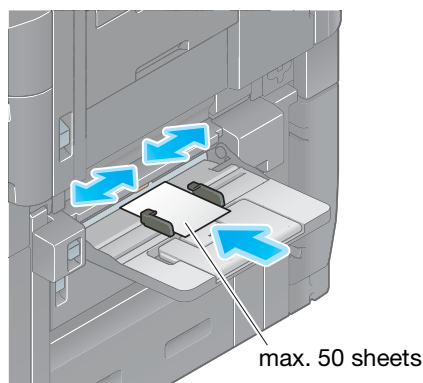

NOTICE

When loading postcards into the **Bypass Tray**, note the following points.

→ When loading curled postcards, uncurl the postcards as shown in the figure in advance.

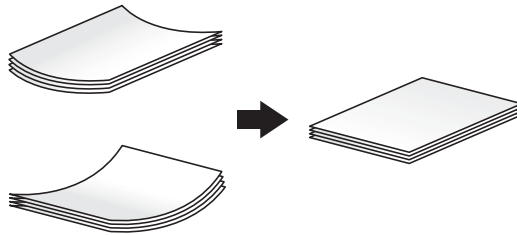

→ Do not put spare postcards in the **Bypass Tray**. Doing so causes a size detection error.

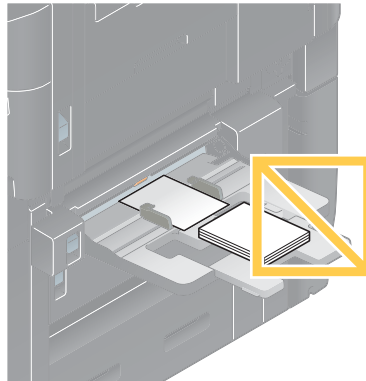

The screen for selecting the paper type and paper size appears.

2 Change the paper size setting.

→ In [Paper Size] - [Envelope/4 × 6] ([Envelope/A6 Card]), select [4 × 6] ([A6 Card]). Selecting [4 × 6] ([A6 Card]) sets [Paper Type] to [Thick3].

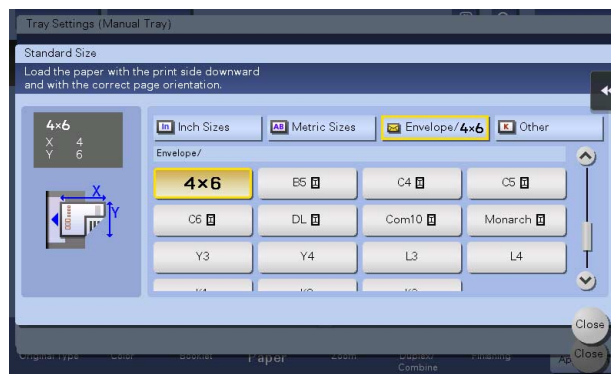

Loading transparencies

Up to 20 transparencies can be loaded into the tray.

- 1 Load transparencies in the  direction as shown in the figure with the print side facing down, then align the **Lateral Guide** to the paper.

→ Insert transparencies into the tray until their edges are pressed against the back.

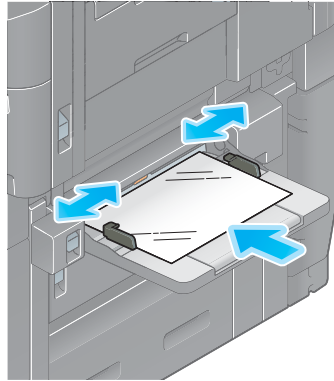

The screen for selecting the paper type and paper size appears.

- 2 Change the paper type setting.

→ Select [Transparency] from [Paper Type].

→ Transparencies can only be printed in black. When the color function is other than black and [Transparency] is selected, check the displayed message, and tap [Yes].

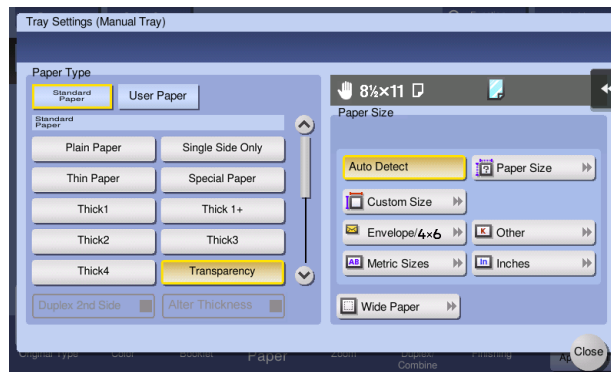

Loading envelopes

Up to 10 envelopes can be loaded into the tray.

Image of a long envelope



Image of a Western-style envelope



- 1 Load envelopes as shown in the figure with the flap part facing up, then align the **Lateral Guide** to them.
 - Insert envelopes into the tray until their edges are pressed against the back.
 - The flap side of envelopes cannot be printed on.

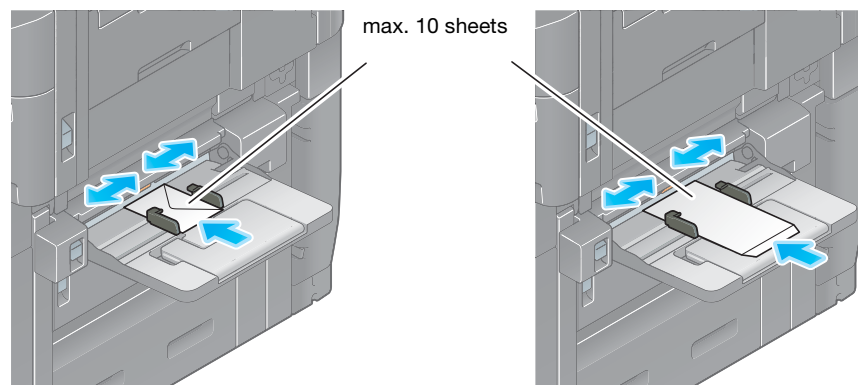

NOTICE

When loading envelopes into the **Bypass Tray**, note the following points.

- When loading envelopes, remove air from them, and securely press along the flap fold line. Otherwise, it will result in an envelope wrinkle or paper jam.

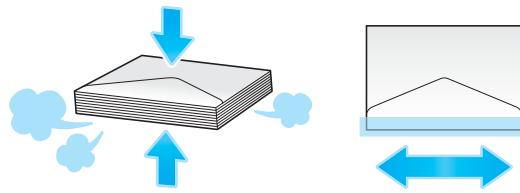

- Do not use envelopes that have glue or release paper on the flap or the part covered by the flap on the body. Otherwise, the machine may be damaged or a failure may occur.
- Do not put spare envelopes in the **Bypass Tray**. Doing so causes a size detection error.

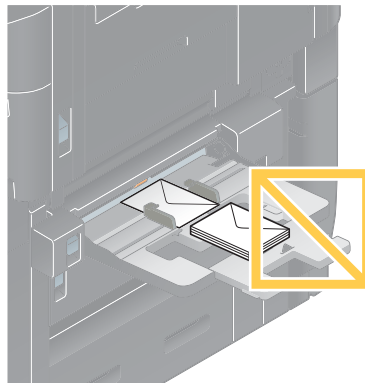

The screen for selecting the paper type and paper size appears.

- 2 Tap [Envelope/4 × 6] ([Envelope/A6 Card]) from [Paper Size].

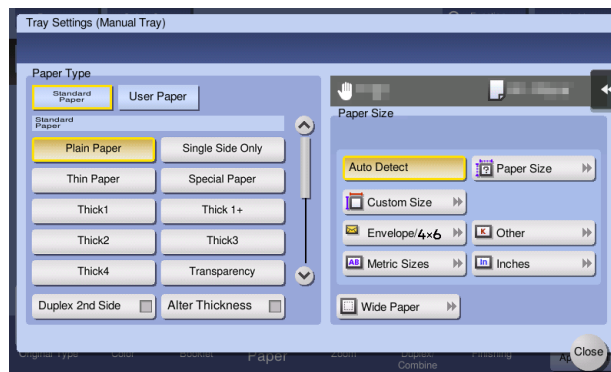

- 3 Select the envelope size from [Envelope/4 × 6] ([Envelope/A6 Card]).
 - Various sizes of envelopes are available. Specify the correct paper size for the envelopes you have loaded. When the envelope size is specified, [Paper Type] is automatically set to [Envelope].

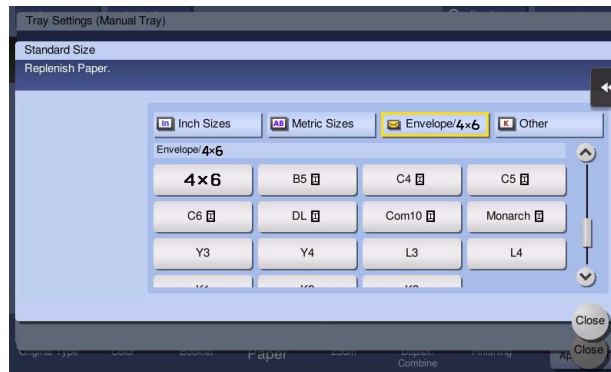

NOTICE

When loading envelopes with flaps opened, also select the standard size that matches them. You do not have to measure the size of the envelope with the flap opened to set the size as a custom-sized envelope.

Loading label sheets

Up to 50 label sheets can be loaded into the tray.

- 1 Load label sheets in the  direction as shown in the figure with the print side facing down, then align the **Lateral Guide** to the paper.
 - Insert label sheets into the tray until their edges are pressed against the back.

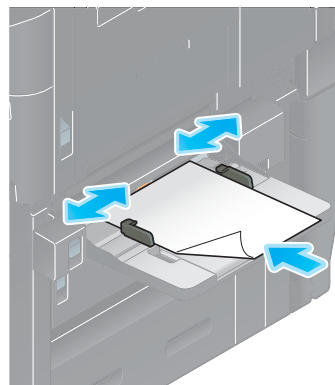

The screen for selecting the paper type and paper size appears.

- 2 Change the paper type setting.
 - Select [Thick 1+] from [Paper Type].

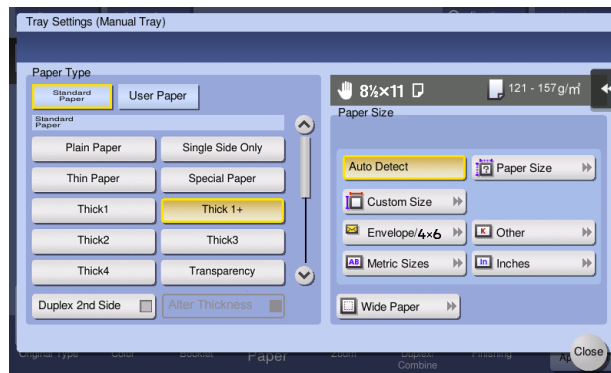

Loading index papers

Up to 70 index papers can be loaded into the tray.

- 1 Put the tab side in the direction opposite to this machine with the print side facing down, then align the **Lateral Guide** to the paper.
 - Insert index papers into the tray until their edges are pressed against the back.

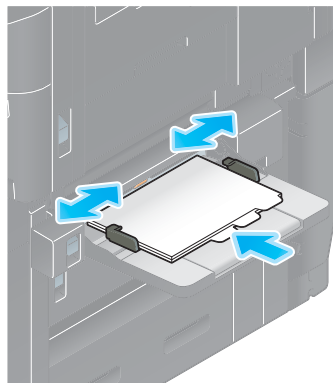

The screen for selecting the paper type and paper size appears.

- 2 Change the paper type setting.
 - Select [Index Paper] from [Paper Type].

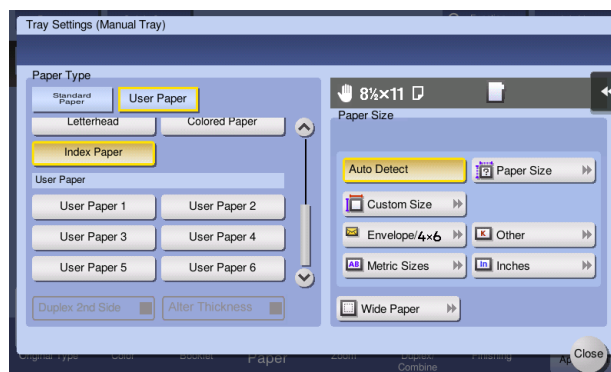



Basic Settings and Operations

3 Basic Settings and Operations

3.1 Print function

3.1.1 Required settings and basic operations (for Windows OS)

Print data created on your computer via the network.

This section describes how to configure standard print settings using the installer.



Preparation flow

The following describes a preparation flow to print data. For details, refer to the relevant page.

This preparation is not required the second time or subsequent times.

- 1** Checking the cable connection (Administrator)
 - Check that this machine is correctly connected to the network cable. For details, refer to page 3-4.
- 2** Checking network settings of this machine (Administrator)
 - Check the network settings of this machine. For details, refer to page 3-4.
 - You can use this function with the default settings unless otherwise requested.
- 3** Installing the printer driver
 - Install the printer driver on the computer. For details, refer to page 3-5.

Operation flow

The following describes a flow to print data from your computer. For details, refer to page 3-5.

- 1 Opening original data
 - Open the data you want to print using the application software.
- 2 Configuring the printer driver for printing
 - Select a printer driver, and change the setting if necessary before printing.

Checking the cable connection

Check that a LAN cable is connected to the LAN port of this machine and the green LED is on.

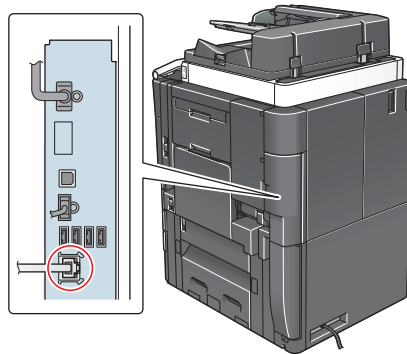

Checking network settings of this machine

Tap [Utility], and select [Device Information]. Check that the IP address is displayed.

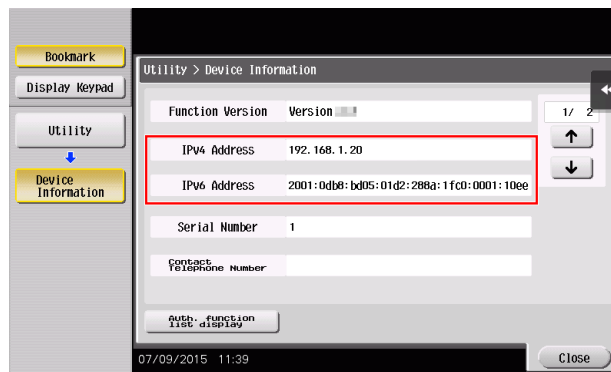

Tips

- In general, the default settings are available for network connection; however, some network environments require a change on network settings.
- If no IP address is displayed, you need to set up the network. Tap [Utility], and select [Administrator Settings] - [Network Settings] - [TCP/IP Settings]. Configure the required settings to suit your environment. For details, refer to the User's Guide CD/DVD.

- For information on the default administrator password, refer to the User's Guide CD/DVD.

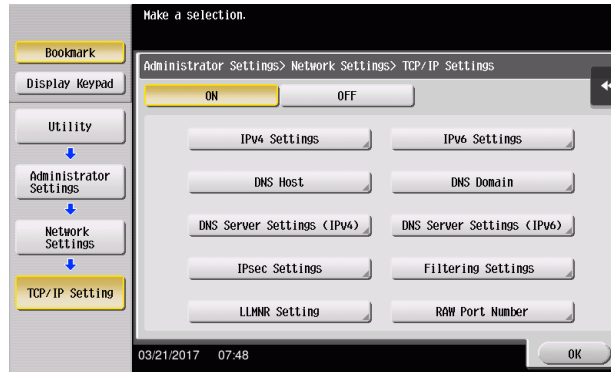

Installing the printer driver

Install the printer driver using the installer.

- ✓ Administrator privileges are required to perform this task.
- 1 Insert the printer driver DVD into the DVD drive of the computer.
 - 2 Select [Agree the Software End User License Agreement.] and [Install printers/MFPs], and click [Next].
 - 3 Select this machine from the list of detected printers.
 - ➔ If multiple identical models are displayed, check the IP address to select an appropriate one. For details on how to check the IP address of this machine, refer to page 3-4.
 - 4 As needed, select [Specify manually.], specify the type of the printer driver you want to install.
 - 5 Click [Next].
 - 6 Click [Install].
 - 7 Click [Finish].

Printing data

- 1 Open the data you want to print using the application software.
- 2 In the [File] menu, click [Print].
- 3 Select the installed printer driver, and click [Print].

Tips

- Clicking [Preferences] can change the setting of the printer driver as required.
- If user authentication is enabled in this machine, specify the required data such as the user name and password.

Types of printer drivers

Select a printer driver that will meet your printing requirements.

Driver type	Description
PCL	This is a standard driver for printing general office documents. Among the three drivers, this driver provides the fastest printing speed.
PS	This driver is effective for high-definition printing of data created in PostScript-supporting application software from Adobe or other vendors. This driver is often used in graphics and light printing applications where good color reproducibility is important.

3.1.2 Required settings and basic operations (for Mac OS)

Print data created on your computer via the network.

This section describes how to configure a printer driver, for Mac OS 10.9 environment, Bonjour connection, and use of metric-size paper as major conditions.



Preparation flow

The following describes a preparation flow to print data. For details, refer to the relevant page.

This preparation is not required the second time or subsequent times.

- 1** Checking the cable connection (Administrator)
 - Check that this machine is correctly connected to the network cable. For details, refer to page 3-7.
- 2** Checking network settings of this machine (Administrator)
 - Check the network settings of this machine. For details, refer to page 3-7.
 - You can use this function with the default settings unless otherwise requested.
- 3** Installing the printer driver
 - Install the printer driver on the computer. For details, refer to page 3-9.
- 4** Adding and configuring a printer driver
 - Set up your computer so that data can be printed using the installed printer driver. For details, refer to page 3-9.

Operation flow

The following describes a flow to print data from your computer. For details, refer to page 3-10.

- 1 Opening original data
 - Open the data you want to print using the application software.
- 2 Configuring the printer driver for printing
 - Select a printer driver, and change the setting if necessary before printing.

Checking the cable connection

Check that a LAN cable is connected to the LAN port of this machine and the green LED is on.

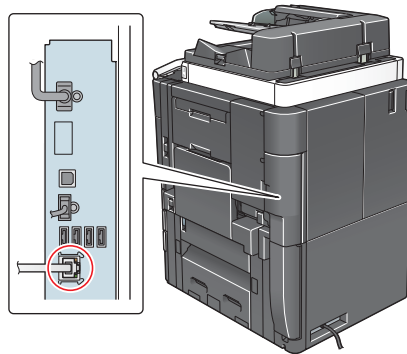

Checking network settings of this machine

- 1 Tap [Utility], and select [Device Information]. Check that the IP address is displayed.

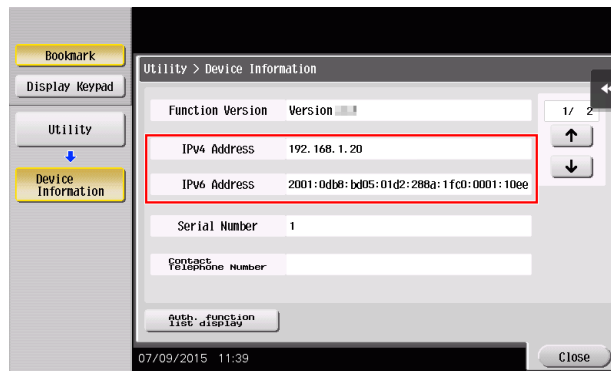

- 2 Specify the Bonjour name. Tap [Utility], and select [Administrator Settings] - [Network Settings] - [Bonjour Setting] - [ON].

→ For information on the default administrator password, refer to the User's Guide CD/DVD.

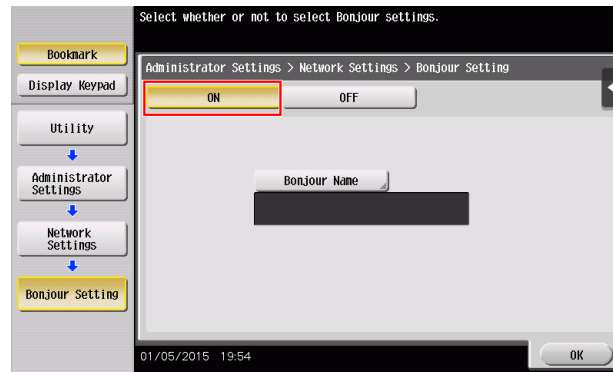

→ The Bonjour name is displayed on the printer driver as a connected device name.

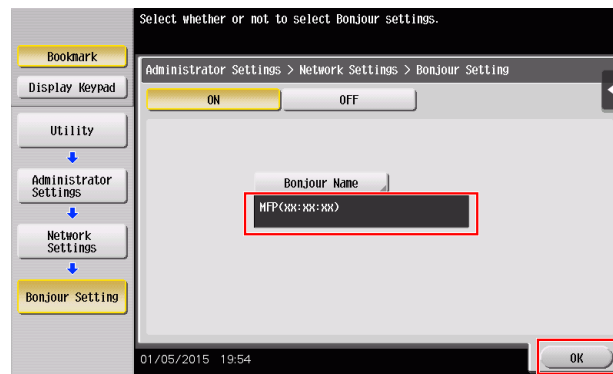

→ To change the Bonjour name, tap [Bonjour Name], and enter the name using the displayed keyboard.

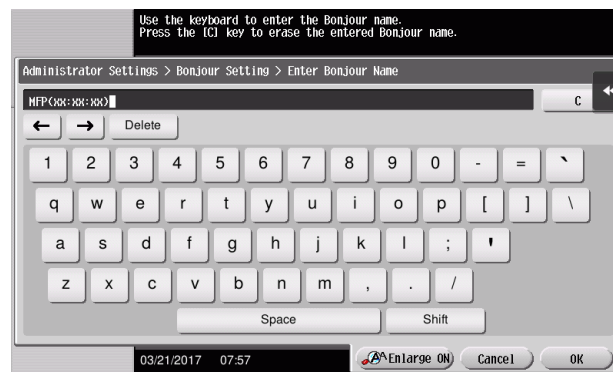

Tips

- If no IP address is displayed, you need to set up the network. Tap [Utility], and select [Administrator Settings] - [Network Settings] - [TCP/IP Settings]. Configure the required settings to suit your environment. For details, refer to the User's Guide CD/DVD.

- For information on the default administrator password, refer to the User's Guide CD/DVD.

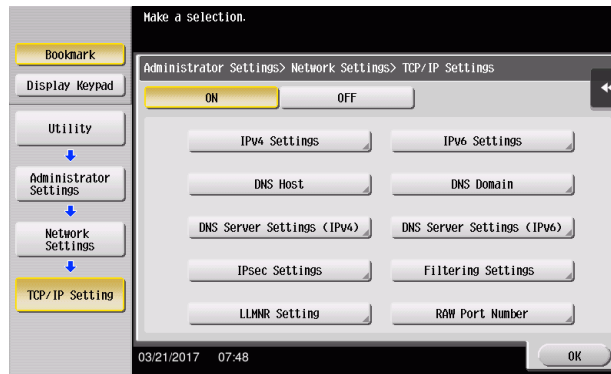

Installing the printer driver

Install the printer driver using the installer.

- ✓ Administrator privileges are required to perform this task.
- 1 Insert the printer driver DVD into the DVD drive of the computer.
 - 2 Select the target printer driver, and copy it to the desktop.
 Example: /Driver/OS_10_9_x/Letter/XXX_109.pkg (Printer driver for Mac OS 10.9 or later)
 - "XXX" indicates the model name.
 - When ordinarily using metric-sized paper, select a printer driver in the "A4" directory.
 - The last three digits of the printer driver name indicate the version of the operating system.
 - 3 Double-click the file copied onto the desktop.
 - 4 Proceed with the procedure according to the on-screen instructions until the installation screen appears.
 - 5 Click [Install].
 - 6 When a prompt message appears to ask you to enter the name and password, type in the name and password of the user with administrator privileges.
 - 7 Click [Close].

Adding and configuring a printer driver

Set up your computer so that data can be printed using the installed printer driver.

- ✓ Administrator privileges are required to perform this task.
- 1 In the Apple Menu, click [System Preferences] - [Printers & Scanners].
 - 2 Click [+].
 - 3 Select a printer from the displayed list of printers.
 - If you cannot identify the connected machine because the same product name is listed multiple times, check with the administrator.
 - If the target printer name is not displayed, select [Add Other Printer or Scanner] or [Add Printer or Scanner] to set up the printer. For details, refer to the User's Guide CD/DVD.
 - 4 Select the installed optional units.

Printing data

- 1 Open the data you want to print using the application software.
- 2 From the [File] menu, select [Print].
- 3 Select the Bonjour name of this machine.



Tips

- If necessary, you can click [Show Details] to change the settings of the printer driver.

3.2 Scan-to-Send function

3.2.1 Various transmission methods

The original data scanned by this machine can be sent and saved using a variety of methods.

Sending data to your computer (SMB Send)

Send scanned data to a computer on the network. Once settings are configured, you can send data easily. For details, refer to page 3-12 and page 3-20.

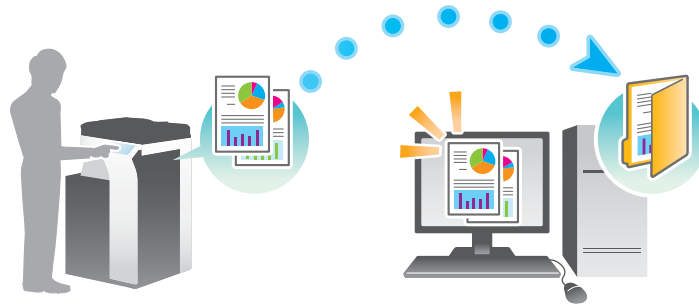

Transmitting data as E-mail attachment (E-mail TX)

Send scanned data as an E-mail attachment. This function is useful when you want to forward data to an outside location. For details, refer to page 3-28.

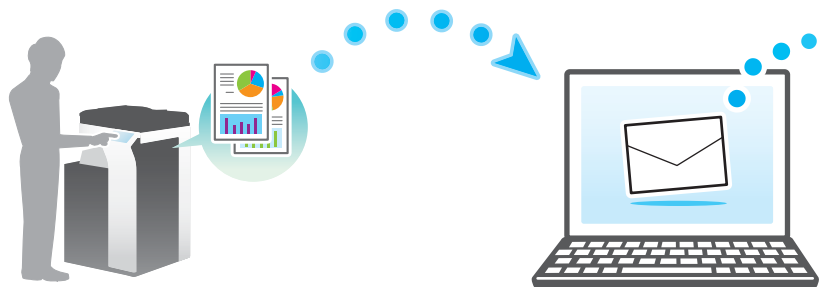

Saving data to the USB memory device (External memory)

Directly save scanned data on the USB memory device connected to this machine. For details, refer to page 3-64.



Various methods for transmitting and saving data

In addition to the above, data can be sent and saved in various methods. Select the appropriate one to meet your needs.

- Issuing a scan instruction from a computer (Web service function)
- Saving data to a User Box on the HDD (Save in User Box)
- Sending to an FTP server (FTP Send)
- Sending to a WebDAV server (WebDAV Send)



Reference

For details, refer to the User's Guide CD/DVD.

3.2.2 Sending data to your Windows computer (SMB Send)

Send scanned data to a computer on the network.

Once settings are configured, you can send data easily.

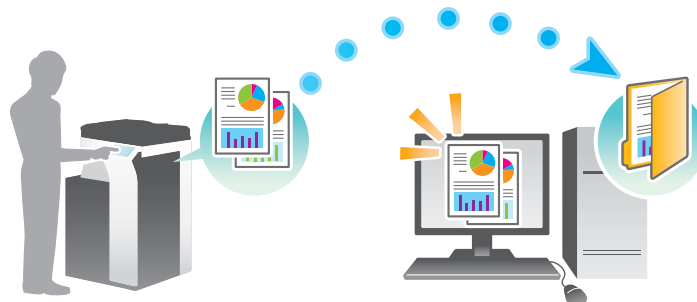

Preparation flow

The following describes a preparation flow for sending scanned data. For details, refer to the relevant page. This preparation is not required the second time or subsequent times.

- 1 Checking the cable connection (Administrator)
 - Check that this machine is correctly connected to the network cable. For details, refer to page 3-13.
- 2 Checking network settings of this machine (Administrator)
 - Check the network settings of this machine. For details, refer to page 3-14.
 - You can use this function with the default settings unless otherwise requested.
- 3 Checking computer information
 - Check the information required for Store Address, and fill out the checklist. For details, refer to page 3-15.
- 4 Configuring your computer
 - Configure settings to share a computer, or create a dedicated folder to receive files. For details, refer to page 3-15.
- 5 Registering destinations
 - Register destinations to which files are sent while checking the checklist. For details, refer to page 3-16.

Operation flow

The following describes a transmission flow. For details, refer to page 3-18.

- 1 Loading the original
- 2 Selecting a destination
 - Select a registered destination, and check the settings such as the file type and image quality.
- 3 Press the **Start** key.
 - Press the **Start** key to scan the original.

Checking the cable connection

Check that a LAN cable is connected to the LAN port of this machine and the green LED is on.

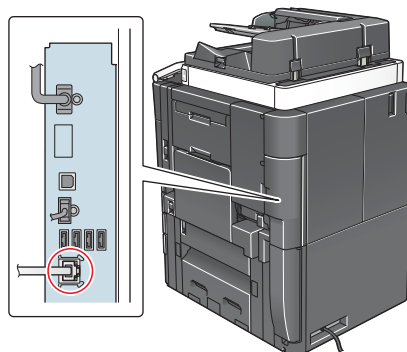

Checking network settings of this machine

Tap [Utility], and select [Device Information]. Check that the IP address is displayed.

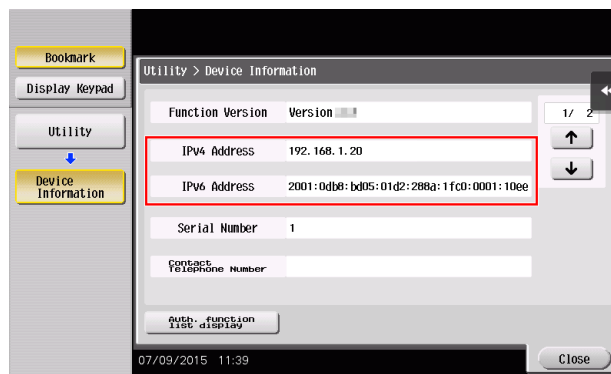

Tips

- In general, the default settings are available for network connection; however, some network environments require a change on network settings.
- If no IP address is displayed, you need to set up the network. Tap [Utility], and select [Administrator Settings] - [Network Settings] - [TCP/IP Settings]. Configure the required settings to suit your environment. For details, refer to the User's Guide CD/DVD.
- For information on the default administrator password, refer to the User's Guide CD/DVD.

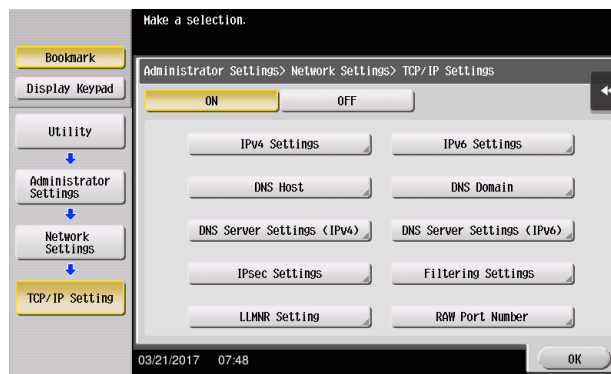

Checklist

While making notes in the checklist shown below, check computer information and configure settings for preparation. The completed checklist is used for Store Address.

Name	Entry column	Detail
Host Address	Host name or IP address to which the scanned data is sent	page 3-15
File Path	Name of the dedicated folder to receive the scanned data	page 3-15
User ID	User name required to log in to the computer	page 3-15
Password	Password required to log in to the computer <ul style="list-style-type: none"> • You should not enter this column for security reasons. 	Contact your system administrator.

Checking computer information

Check the host address and user ID, and write them down.

- 1 Display the Properties window of the computer.
 - In Windows 8.1/10, while pressing the [Windows] (⊞) key, press the [X] key, and then select [System properties] in the displayed menu.
 - In Windows 7, from the Start menu, select [Computer] - [System properties].
- 2 Check the computer name, and write it down in the Host address column of the checklist.
- 3 Open the command prompt.
 - In Windows 8.1/10, while pressing the [Windows] (⊞) key, press the [X] key, and then select [Command Prompt] in the displayed menu.
 - In Windows 7, from the Start menu, select [All Programs] - [Accessories] - [Command Prompt].
- 4 Check the user name, and write it down in the User ID column of the checklist.

Configuring your computer

Create a new folder, and enable the sharing settings.

- ✓ Administrator privileges are required to perform this task.

- 1 Display the Network and Sharing Center window to configure a sharing setting.
 - In Windows 8.1/10, while pressing the [Windows] (⊞) key, press the [X] key, and select [Control Panel] - [Network and Sharing Center] - [Change advanced sharing settings] in the displayed menu, then select the [Turn on file and printer sharing] check box.
 - In Windows 7, from the Start menu, select [Control Panel] - [Network and Internet] - [Network and Sharing Center] - [Change advanced sharing settings] then select the [Turn on file and printer sharing] check box.
- 2 Create a new folder, and write down the folder name in the File path column of the checklist.
- 3 Configure the setting to share the folder created in Step 2. Right-click on the folder, then click [Properties].
- 4 Click the [Sharing] tab, and also click [Advanced Sharing].
- 5 Select the [Share this folder] check box, then click [Permissions].
- 6 Select [Everyone] from the [Group or user names:] list, then select all of the [Allow] check boxes.

Registering destinations

While checking the created checklist, register the folder for receiving the scanned data as an address book of this machine.

- 1 Tap [Utility], and select [One-Touch/User Box Registration] - [Create One-Touch Destination] - [Address Book] - [PC (SMB)].

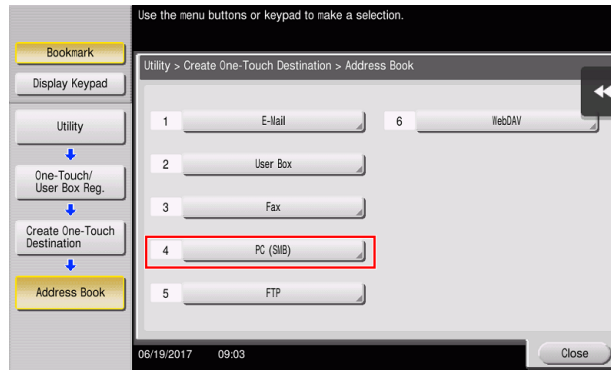

- 2 Tap [New].

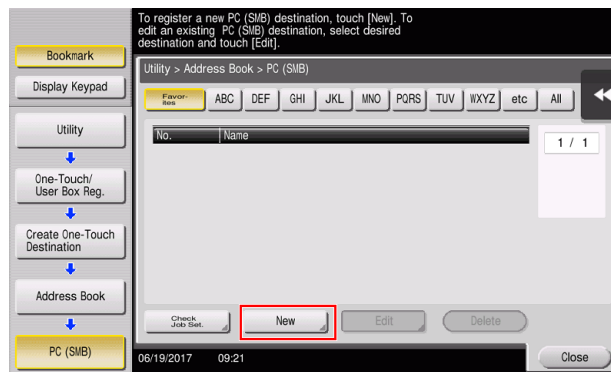

- 3 For [Name], specify the name to be displayed on the assigned key.
→ For [Sort Character], enter the same name as [Name].

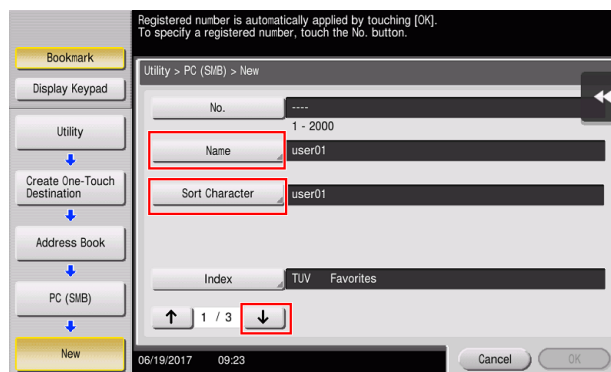

- This sets the appropriate index for the name, which you entered into [Name], to [Index]. To change the setting, tap [Index].

- 4 While checking the checklist, enter the user ID and password you wrote down.

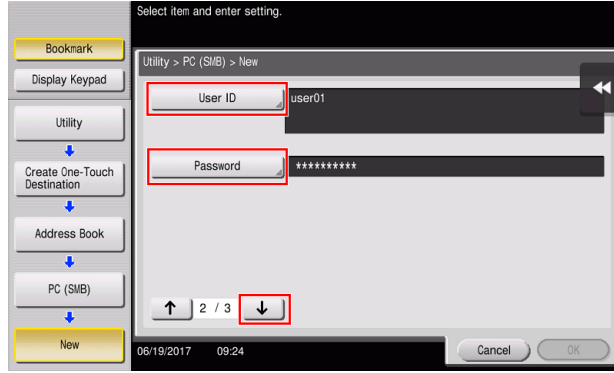

- 5 While checking the checklist, enter the host address and file path you wrote down.

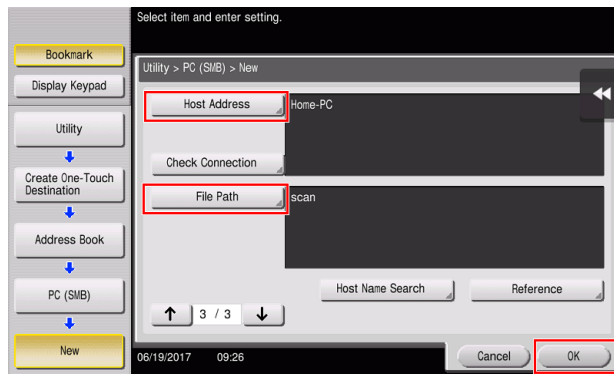

- 6 Tap [Close].

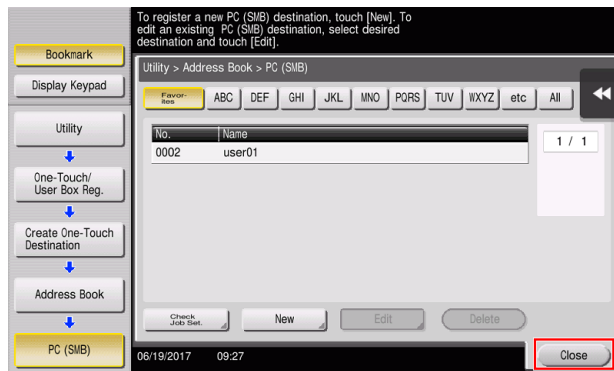

Sending the original

- 1 Load the original.

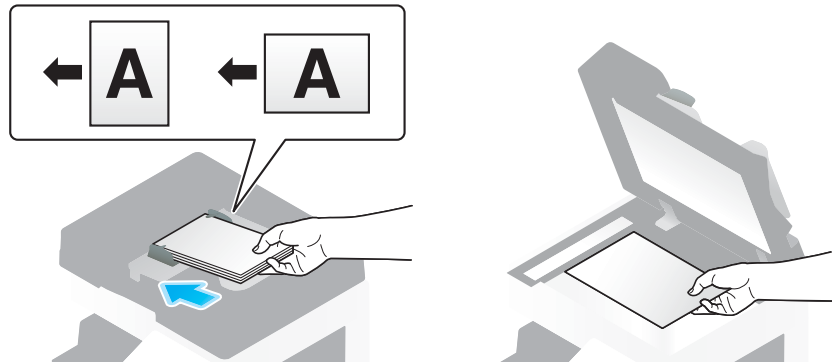

- 2 Tap [Scan/Fax].

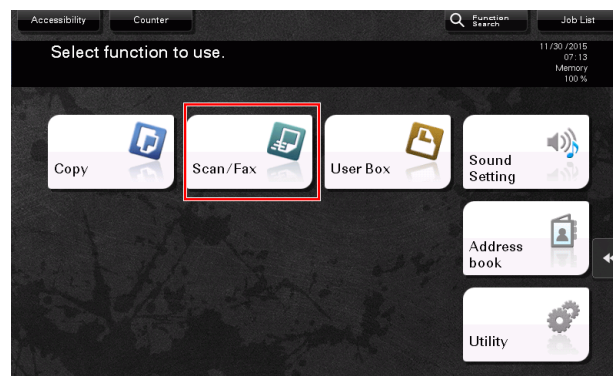

- 3 Select a destination.

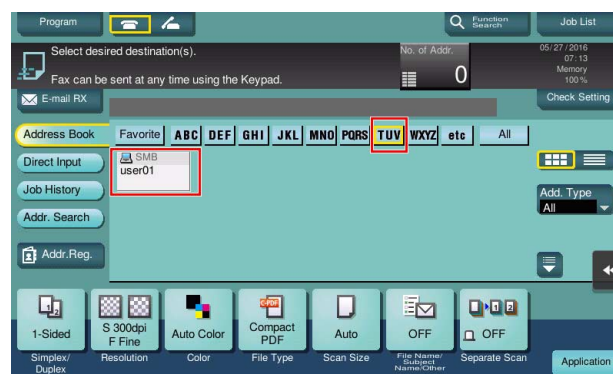

- 4 Check the setting if necessary.
 → Tap [Check Setting] to check the setting.

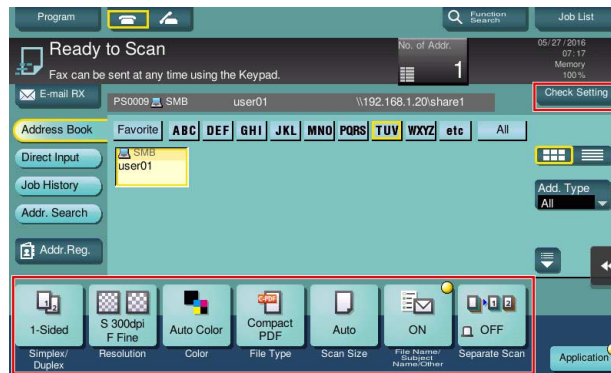

- You can also check the setting using the keys displayed on the **Touch Panel**.
 → To change the setting, tap the desired key on the **Touch Panel**.

Settings	Description
[Simplex/Duplex]	Select whether to scan one or both sides of the original.
[Resolution]	Specify the scanning resolution.
[Color]	Select whether to scan the original in color or black and white mode.
[File Type]	Select the type of the file to save scanned data.
[Scan Size]	Specify the size of the original to be scanned.
[File Name/Subject Name/Other]	Change the file name or the subject of an E-mail to be sent.
[Separate Scan]	If all pages of the original cannot be loaded into the ADF at one time, change the setting to ON. You can load the pages of the original in several batches and handle them as one job. For details on using the separate scan function, refer to the User's Guide CD/DVD.

- 5 Press the **Start** key.



3.2.3 Sending data to your Mac computer (SMB Send)

Send scanned data to a computer on the network.

Once settings are configured, you can send data easily.



Preparation flow

The following describes a preparation flow for sending scanned data. For details, refer to the relevant page.

This preparation is not required the second time or subsequent times.

- 1** Checking the cable connection (Administrator)
 - Check that this machine is correctly connected to the network cable. For details, refer to page 3-21.
- 2** Checking network settings of this machine (Administrator)
 - Check the network settings of this machine. For details, refer to page 3-21.
- 3** Checking computer information
 - Check the information required for Store Address, and fill out the checklist. For details, refer to page 3-23.
- 4** Configuring your computer
 - Configure settings to share a computer, or create a dedicated folder to receive files. For details, refer to page 3-23.
- 5** Registering destinations
 - Register destinations to which files are sent while checking the checklist. For details, refer to page 3-24.

Operation flow

The following describes a transmission flow. For details, refer to page 3-26.

- 1 Load the Original
- 2 Selecting a destination
→ Select a registered destination, and check the settings such as the file type and image quality.
- 3 Press the **Start** key.
→ Press the **Start** key to scan the original.

Checking the cable connection

Check that a LAN cable is connected to the LAN port of this machine and the green LED is on.

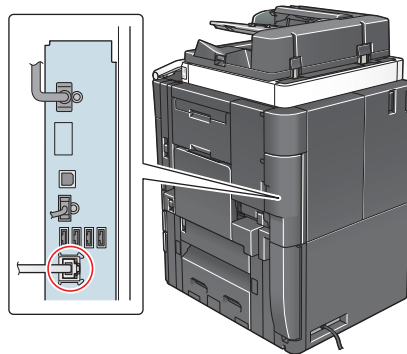

Checking network settings of this machine

Tap [Utility], and select [Device Information]. Check that the IP address is displayed.

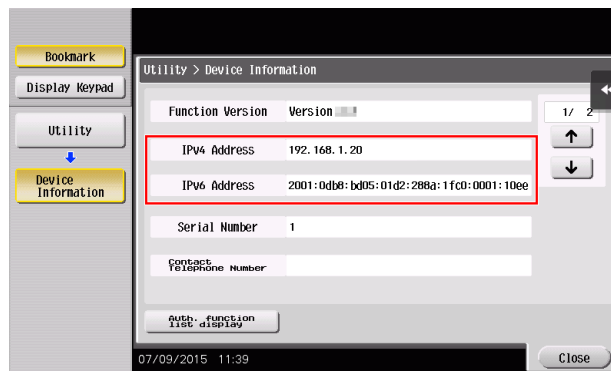

Tips

- If no IP address is displayed, you need to set up the network. Tap [Utility], and select [Administrator Settings] - [Network Settings] - [TCP/IP Settings]. Configure the required settings to suit your environment. For details, refer to the User's Guide CD/DVD.

- For information on the default administrator password, refer to the User's Guide CD/DVD.

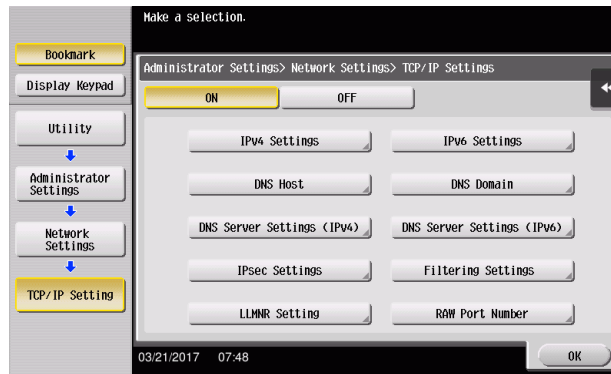

Configuring this machine

The following settings are required.

- Select [NTLM v1/v2] in [Utility] - [Administrator Settings] - [Network Settings] - [SMB Settings] - [Client Settings], then tap [OK].

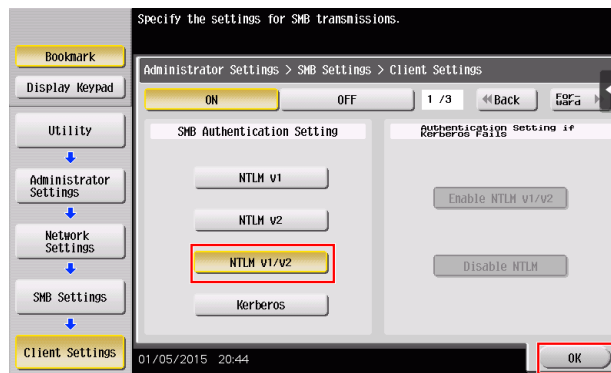

- Select [Utility] - [Administrator Settings] - [System Settings] - [Date/Time Settings] to specify the same date/time and time zone between this machine and your computer, then tap [OK].

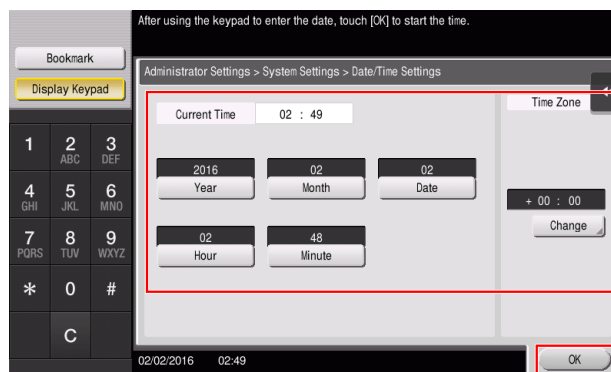

Checklist

While making notes in the checklist shown below, check computer information and configure settings for preparation. The completed checklist is used for Store Address.

Name	Entry column	Detail
Host Address	IP address to which the scanned data is sent	page 3-23
File Path	Name of the dedicated folder to receive the scanned data	page 3-23
User ID	User name required to log in to the computer	page 3-23
Password	Password required to log in to the computer <ul style="list-style-type: none"> • You should not enter this column for security reasons. 	Contact your system administrator.

Checking computer information

Check the host address and user ID.

- ✓ Administrator privileges are required to perform this task.
- ➔ Check the IP address and user name, and write it down in the Host Address and User ID columns of the checklist.

Configuring your computer

Create a new folder, and enable the sharing settings.

- ✓ Administrator privileges are required to perform this task.
- 1 Create a new folder, and write down the folder name in the File path column of the checklist.
 - 2 Enable the folder sharing settings. In the Apple menu, select [System Preferences] - [Sharing].
 - 3 Select the [File Sharing] check box, then click [Options...].
 - 4 Select the [Share files and folders using SMB] and user name check boxes, then click [Done].
 - 5 Under [Shared Folders:], click [+].
 - 6 Select a new folder, then click [Add].
 - 7 Click the new folder to check the access right.
If the access right is changed to [Read & Write], the setting is completed.

Registering destinations

While checking the created checklist, register the folder for receiving the scanned data as an address book of this machine.

- 1 Tap [Utility], and select [One-Touch/User Box Registration] - [Create One-Touch Destination] - [Address Book] - [PC (SMB)].

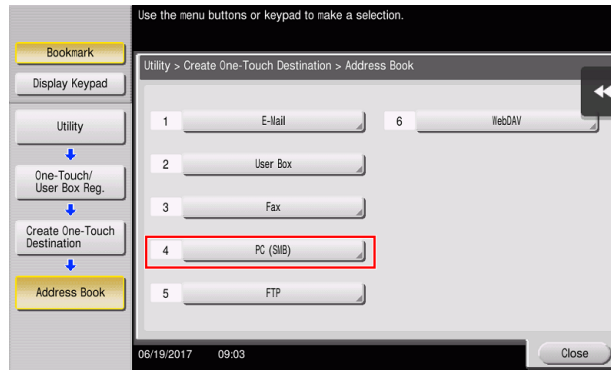

- 2 Tap [New].

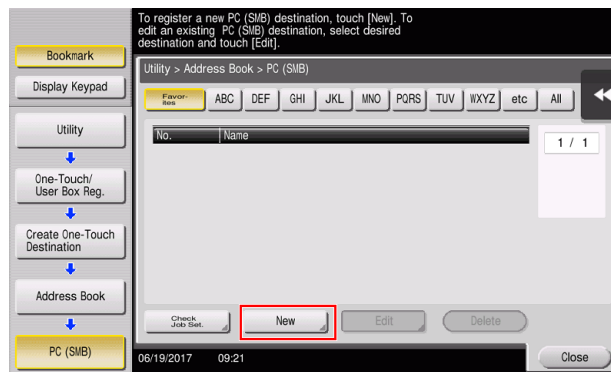

- 3 For [Name], specify the name to be displayed on the assigned key.
→ For [Sort Character], enter the same name as [Name].

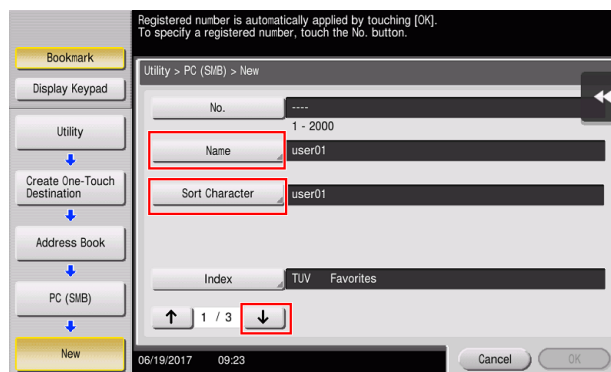

- This sets the appropriate index for the name, which you entered into [Name], to [Index]. To change the setting, tap [Index].

- 4 While checking the checklist, enter the user ID and password you wrote down.

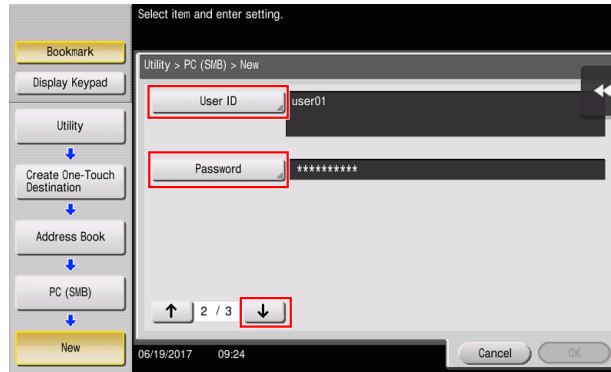

- 5 While checking the checklist, enter the host address and file path you wrote down.

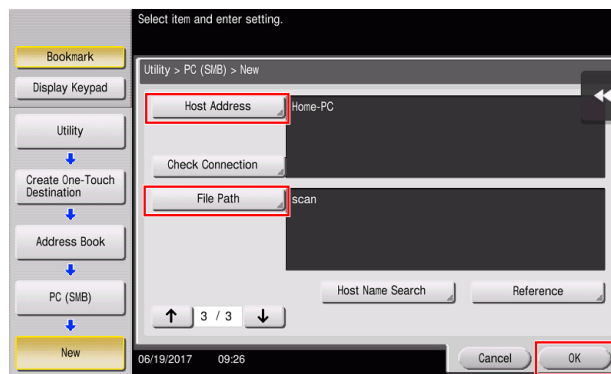

- 6 Tap [Close].

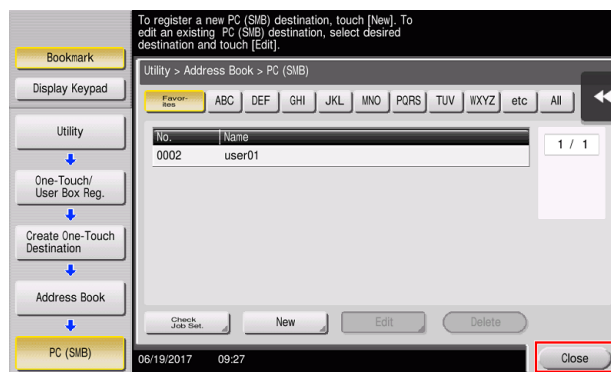

Sending the original

- 1 Load the original.

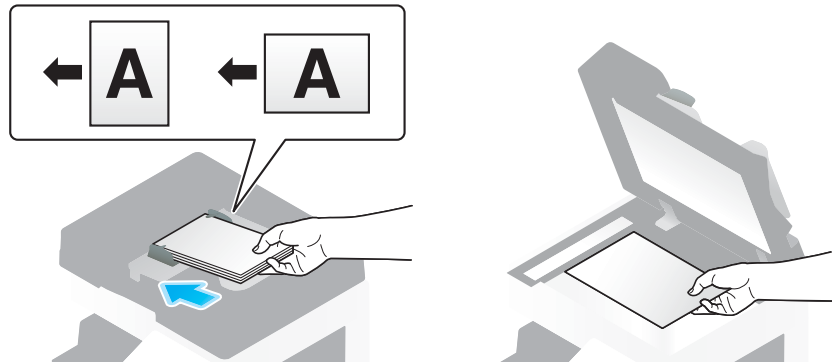

- 2 Tap [Scan/Fax].

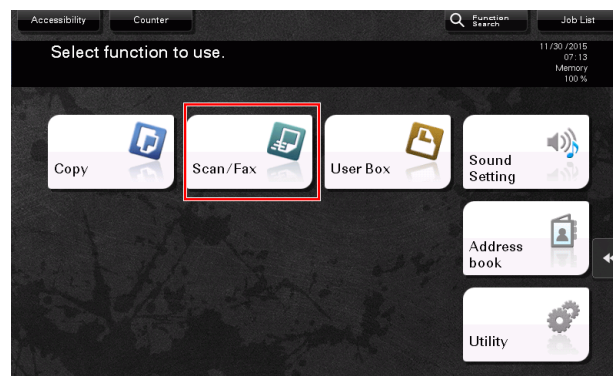

- 3 Select a destination.

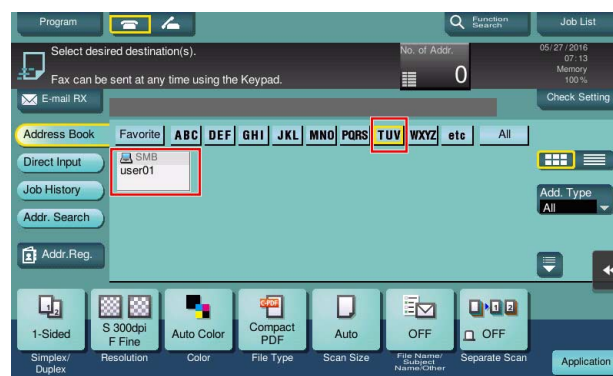

- 4 Check the setting if necessary.
 → Tap [Check Setting] to check the setting.

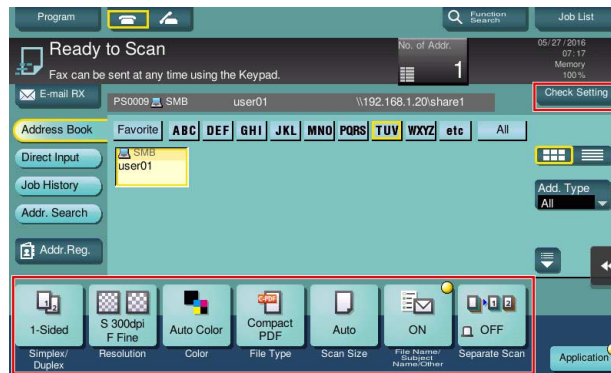

- You can also check the setting using the keys displayed on the **Touch Panel**.
 → To change the setting, tap the desired key on the **Touch Panel**.

Settings	Description
[Simplex/Duplex]	Select whether to scan one or both sides of the original.
[Resolution]	Specify the scanning resolution.
[Color]	Select whether to scan the original in color or black and white mode.
[File Type]	Select the type of the file to save scanned data.
[Scan Size]	Specify the size of the original to be scanned.
[File Name/Subject Name/Other]	Change the file name or the subject of an E-mail to be sent.
[Separate Scan]	If all pages of the original cannot be loaded into the ADF at one time, change the setting to ON. You can load the pages of the original in several batches and handle them as one job. For details on using the separate scan function, refer to the User's Guide CD/DVD.

- 5 Press the **Start** key.



3.2.4 Transmit the scanned data via E-mail (E-mail TX)

Send scanned data as an E-mail attachment.

This function allows you to receive data at an outside location, which is useful when a quick measure is required.

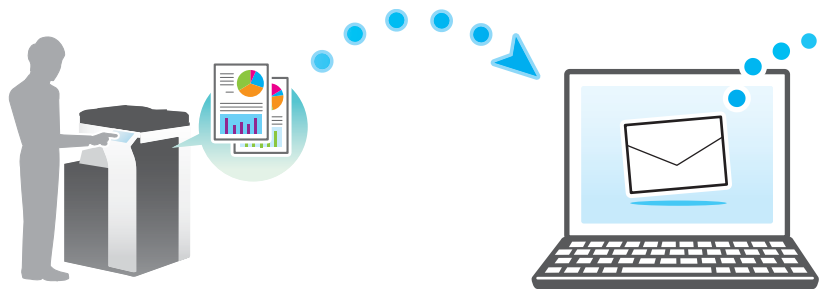

Preparation flow

The following describes a preparation flow for sending scanned data. For details, refer to the relevant page.

This preparation is not required the second time or subsequent times.

- 1** Checking the cable connection (Administrator)
 - Check that this machine is correctly connected to the network cable. For details, refer to page 3-29.
- 2** Checking network settings of this machine (Administrator)
 - Check the network settings of this machine. For details, refer to page 3-29.
- 3** Configuring the E-mail transmission environment (Administrator)
 - Configure a server for E-mail TX. For details, refer to page 3-30.
- 4** Configuring administrator information (Administrator)
 - Register the administrator name and E-mail address used as the sender's address of an E-mail to be sent. For details, refer to page 3-32.

Operation flow

The following describes a transmission flow. For details, refer to page 3-33.

- 1 Load the Original
- 2 Entering a destination
 - Enter the destination E-mail address, and check the settings such as the file type and image quality.
- 3 Press the **Start** key.
 - Press the **Start** key to scan the original.

Checking the cable connection

Check that a LAN cable is connected to the LAN port of this machine and the green LED is on.

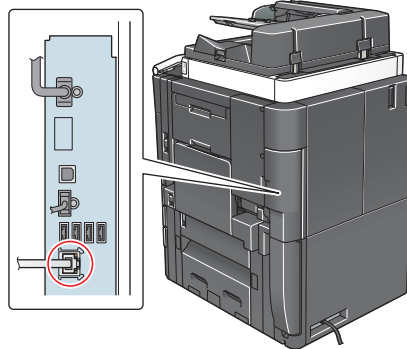

Checking network settings of this machine

Tap [Utility], and select [Device Information]. Check that the IP address is displayed.

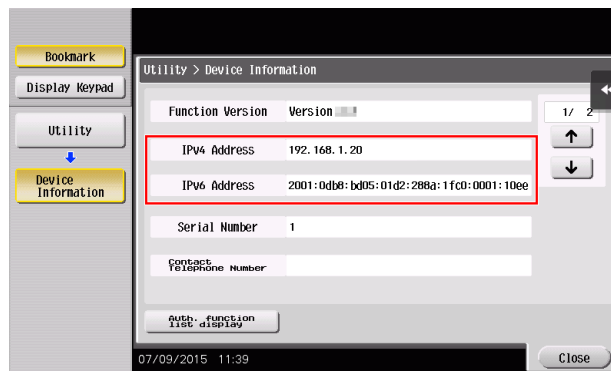

Tips

- In general, the default settings are available for network connection; however, some network environments require a change on network settings.
- If no IP address is displayed, you need to set up the network. Tap [Utility], and select [Administrator Settings] - [Network Settings] - [TCP/IP Settings]. Configure the required settings to suit your environment. For details, refer to the User's Guide CD/DVD.

- For information on the default administrator password, refer to the User's Guide CD/DVD.

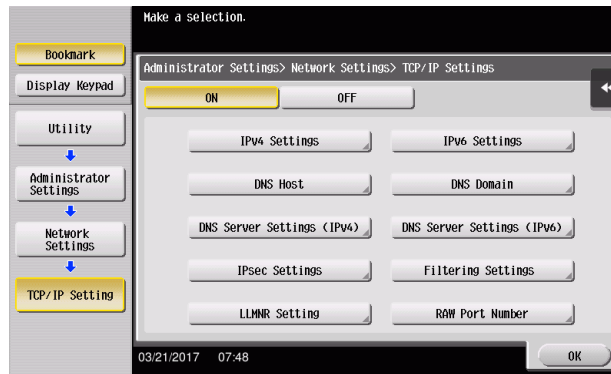

Configuring the E-mail transmission environment

- 1 Tap [Utility], and select [Administrator Settings] - [Network Settings] - [E-Mail Settings].
→ For information on the default administrator password, refer to the User's Guide CD/DVD.

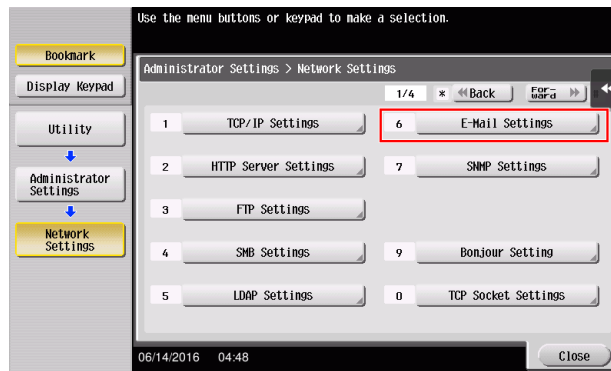

- 2 Tap [E-Mail TX (SMTP)].

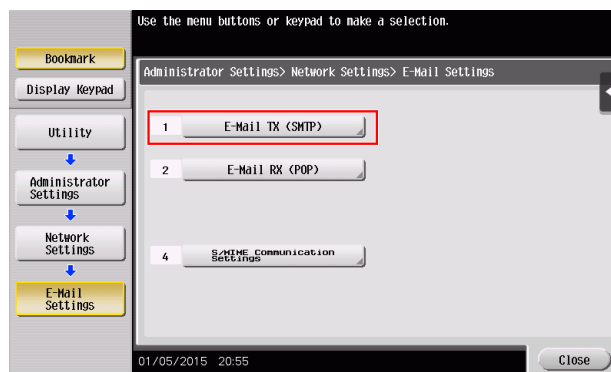

- 3 Select [ON] to enable E-mail TX (SMTP) settings and E-mail TX function.

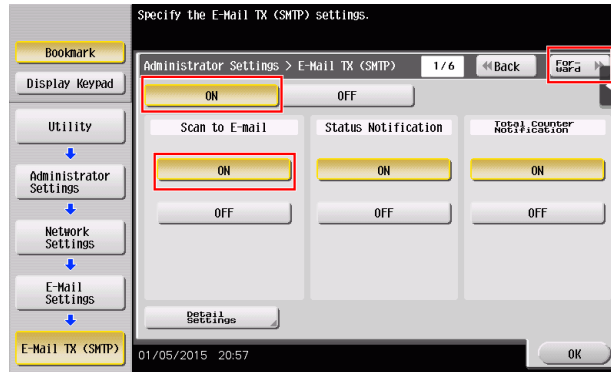

- 4 Enter the SMTP server address.

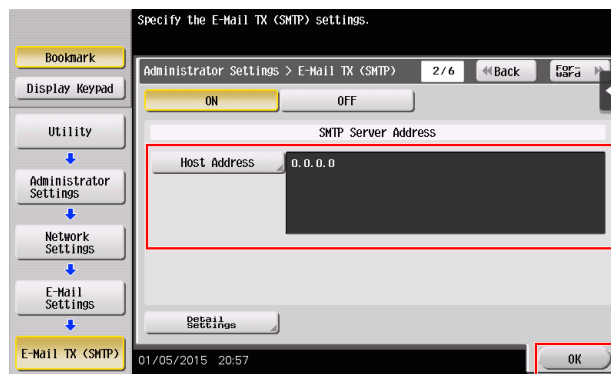

Configuring administrator information

- 1 Tap [Utility], and select [Administrator Settings] - [Administrator/Machine Settings] - [Administrator Registration].

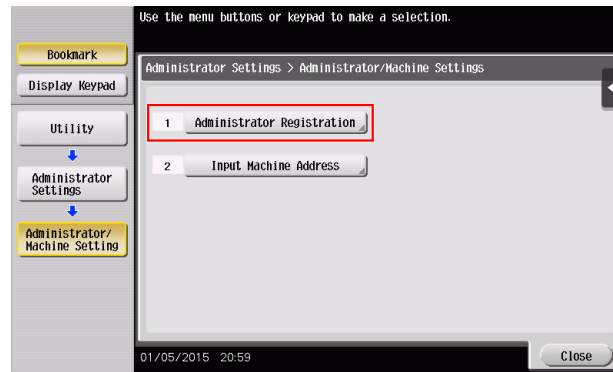

- 2 Enter the required information, then tap [OK].

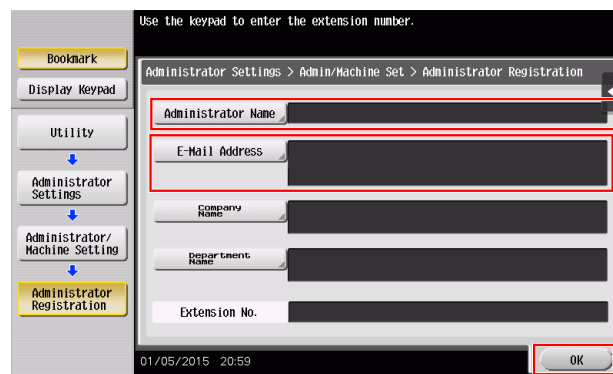

Sending the original

- 1 Load the original.

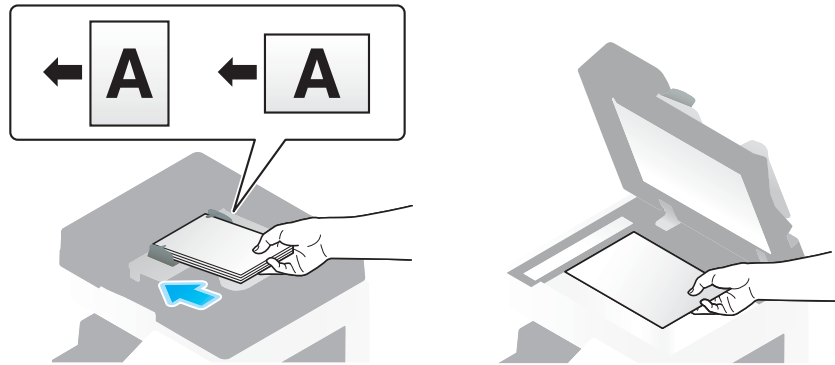

- 2 Tap [Scan/Fax].

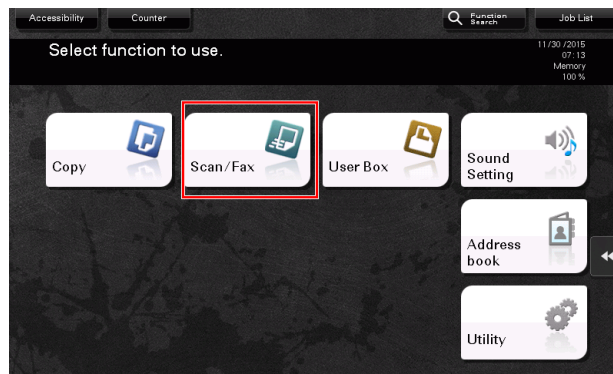

3 Enter a destination.

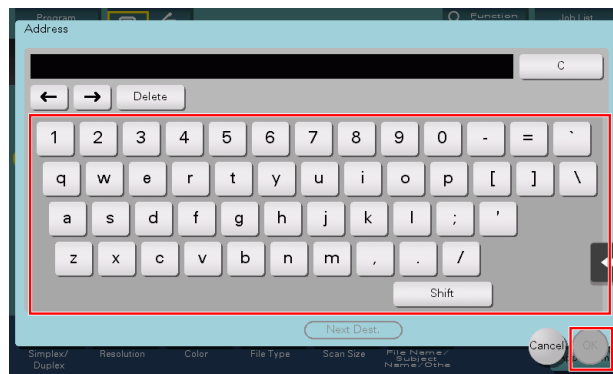
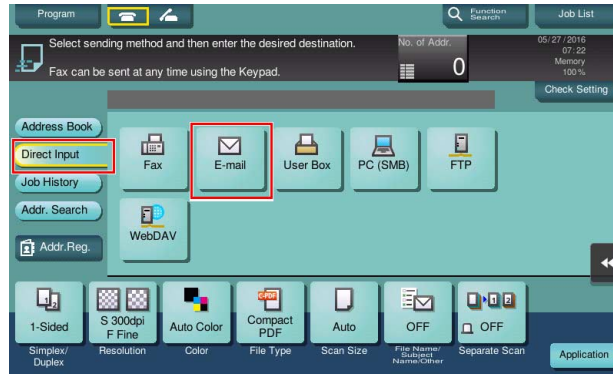

- 4 Check the setting if necessary.
 → Tap [Check Setting] to check the setting.

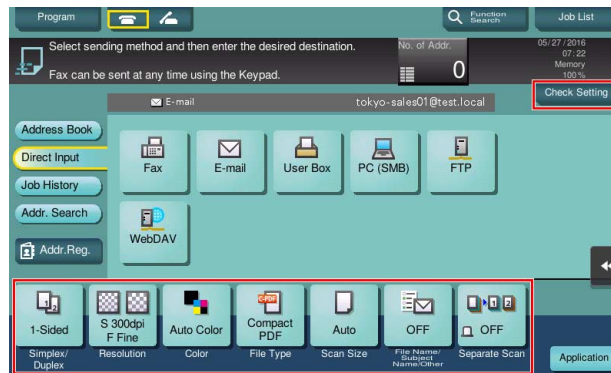

- You can also check the setting using the keys displayed on the **Touch Panel**.
 → To change the setting, tap the desired key on the **Touch Panel**.

Settings	Description
[Simplex/Duplex]	Select whether to scan one or both sides of the original.
[Resolution]	Specify the scanning resolution.
[Color]	Select whether to scan the original in color or black and white mode.
[File Type]	Select the type of the file to save scanned data.
[Scan Size]	Specify the size of the original to be scanned.
[File Name/Subject Name/Other]	Change the file name or the subject of an E-mail to be sent.
[Separate Scan]	If all pages of the original cannot be loaded into the ADF at one time, change the setting to ON. You can load the pages of the original in several batches and handle them as one job. For details on using the separate scan function, refer to the User's Guide CD/DVD.

- 5 Press the **Start** key.



3.3 Fax function

3.3.1 Required settings and basic operations

This section describes the settings required to send and receive a fax via a telephone line as well as the basic operations.

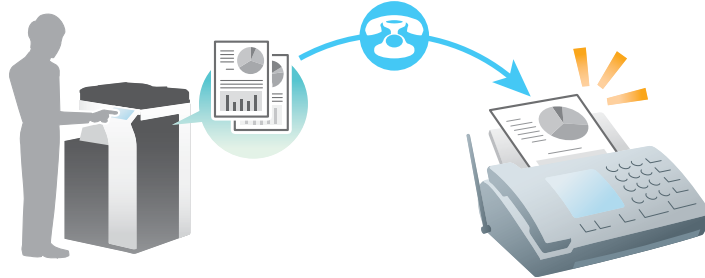

Tips

- To use the Fax function, the optional **Fax Kit** is required.

Preparation flow

The following describes a preparation flow to send a fax. For details, refer to the relevant page.

This preparation is not required the second time or subsequent times.

- 1 Checking the cable connection (Administrator)
 - Check that this machine is correctly connected to the telephone line. For details, refer to page 3-37.
- 2 Registering transmission information (Administrator)
 - Specify the name and fax number to be displayed as a sender when sending a fax from this machine. For details, refer to page 3-37.
- 3 Selecting the dialing method (Administrator)
 - Select the dialing method to suit your environment. For details, refer to page 3-39.

Operation flow

The following describes a flow to send a fax. For details, refer to page 3-40.

- 1 Load the Original
- 2 Entering a destination
→ Enter the destination fax number, and check the settings such as the image quality.
- 3 Press the **Start** key.
→ Press the **Start** key to send the original.

Checking the cable connection

Check that a modular cable is connected to the LINE port of this machine.

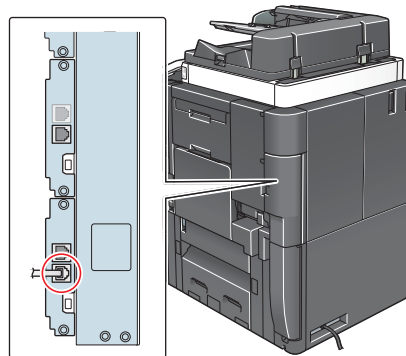

Registering transmission information

- 1 Tap [Utility], and select [Administrator Settings] - [Fax Settings] - [Header Information].
→ For information on the default administrator password, refer to the User's Guide CD/DVD.

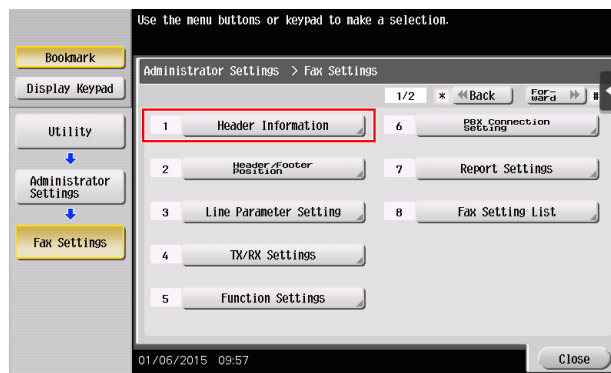

- 2 Enter the sender information, then tap [OK].

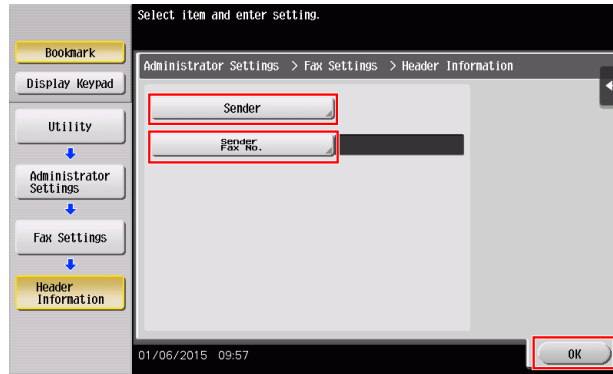

- Sender settings
Enter the name to be displayed as a sender.

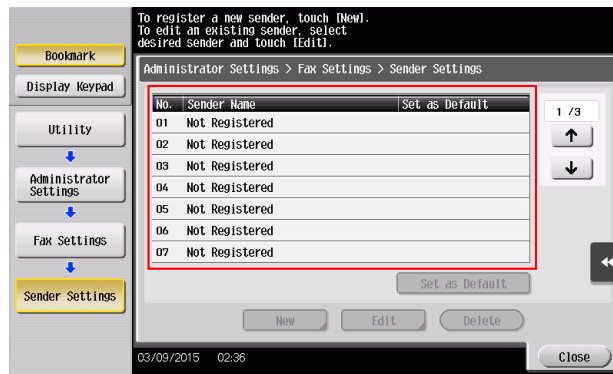

- Sender Fax No. Settings
Enter the fax number to be displayed as a sender.

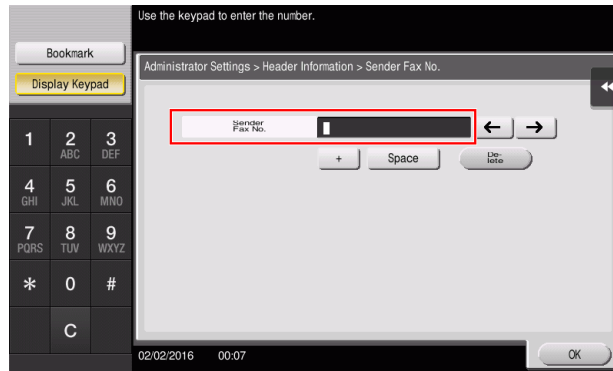

Selecting the dialing method

- 1 Tap [Utility], and select [Administrator Settings] - [Fax Settings] - [Line Parameter Setting].

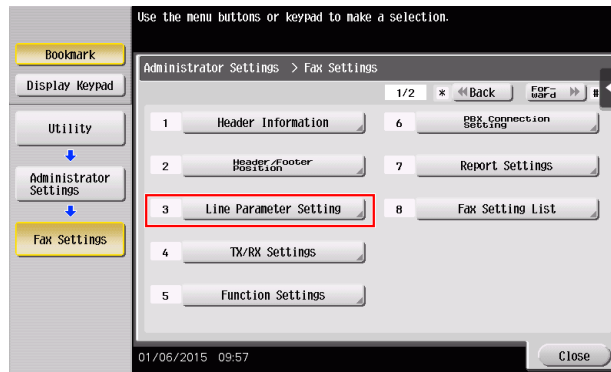

- 2 Tap [Dialing Method].

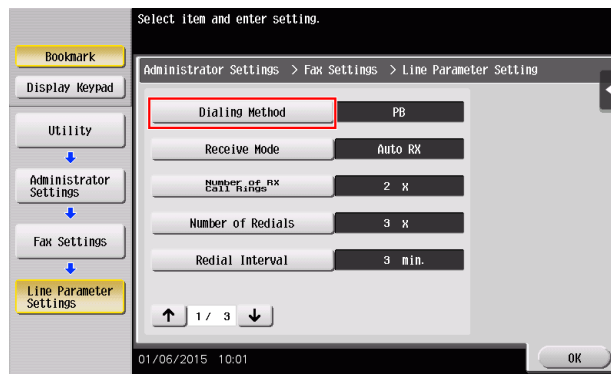

- 3 For the push-button type, select [PB], and for the dial-pulse type, select [10pps].

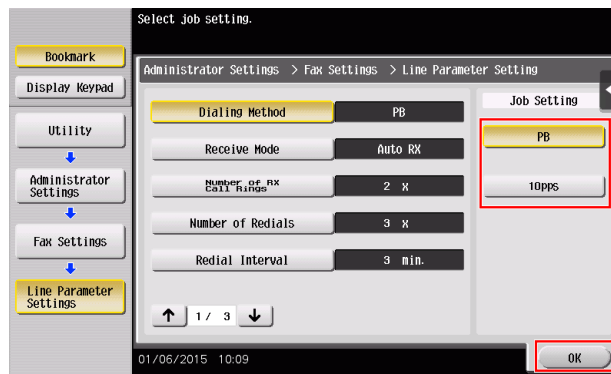

If you do not know the type of the dialing method:

- If you do not know the type of the dialing method, operate push buttons of your phone. When you hear "beep boop beep", set [Dialing Method] to [PB].
- If you do not hear "beep boop beep" after operating push buttons, select [10pps].

Sending the original

- 1 Load the original.

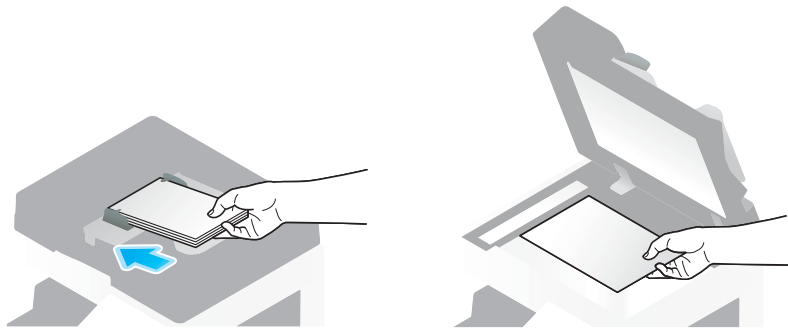

- 2 Tap [Scan/Fax].

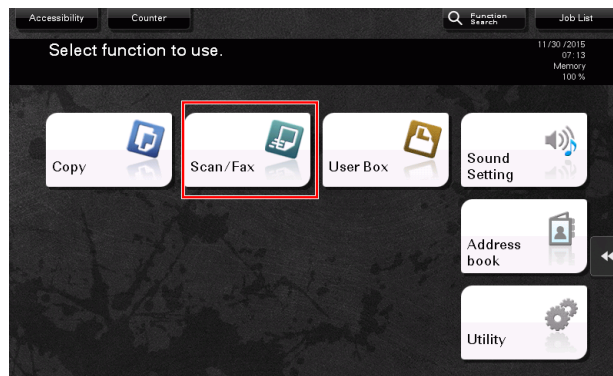

3 Enter a destination.

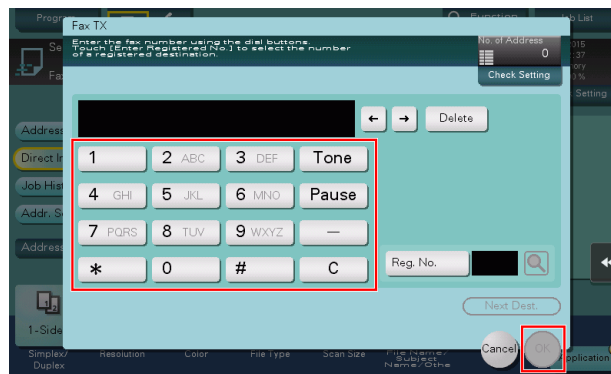
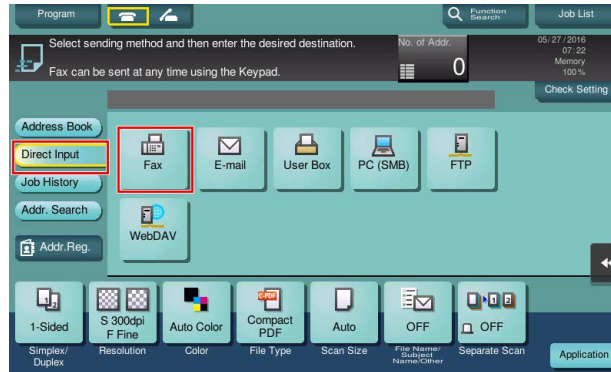
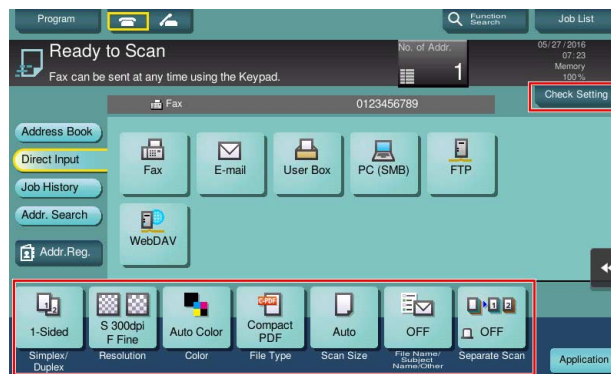
4 Check the setting if necessary.
→ Tap [Check Setting] to check the setting.

→ You can also check the setting using the keys displayed on the **Touch Panel**.

→ To change the setting, tap the desired key on the **Touch Panel**.

[Color], [File Type], and [File Name/Subject Name/Other] are not available when sending to a fax number.

Settings	Description
[Simplex/Duplex]	Select whether to scan one or both sides of the original.
[Resolution]	Specify the scanning resolution.
[Scan Size]	Specify the size of the original to be scanned.
[Separate Scan]	If all pages of the original cannot be loaded into the ADF at one time, change the setting to ON. You can load the pages of the original in several batches and handle them as one job. For details on using the separate scan function, refer to the User's Guide CD/DVD.

- 5 Press the **Start** key.



3.3.2 Sending a fax directly from a PC (PC-FAX TX)

You can send a fax to the destination fax machine in the same manner as you print out data created on your computer.

Advantages to send a fax directly from a computer

- Realizing paper saving
- Completing fax operations without leaving your desk
- Offering clear images by sending data directly from a computer

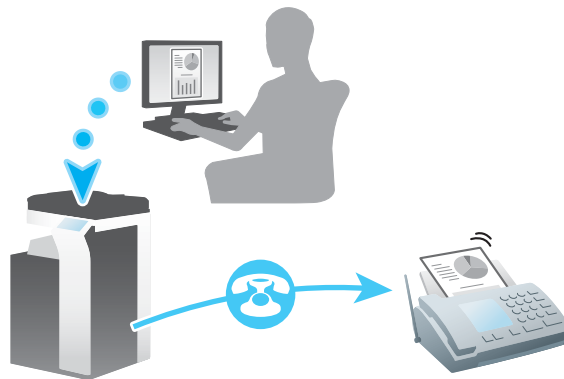

Tips

- To use this function, the optional **Fax Kit** is required.
- This function is not supported in the Mac operating system.

Preparation flow

The following describes a preparation flow to send a fax from a computer. For details, refer to the relevant page.

This preparation is not required the second time or subsequent times.

- 1** Checking the cable connection (Administrator)
 - Check that this machine is correctly connected to the telephone line and network cable. For details, refer to page 3-44.
- 2** Checking network settings of this machine (Administrator)
 - Check the network settings of this machine. For details, refer to page 3-44.
 - You can use this function with the default settings unless otherwise requested.
- 3** Installing the fax driver on your computer
 - Installing the fax driver on your computer For details, refer to page 3-45.

Operation flow

The following describes a flow to send a fax. For details, refer to page 3-45.

- 1** Creating data
 - Create data to be sent using application software.
- 2** Configuring the fax driver
 - Select a fax driver, and change the setting if necessary.
- 3** Entering a destination to send data
 - Enter a destination to send data.

Checking the cable connection

- 1 Check that a modular cable is connected to the LINE port of this machine.

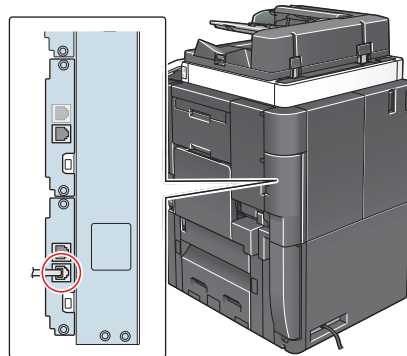

- 2 Check that a LAN cable is connected to the LAN port of this machine and the green LED is on.

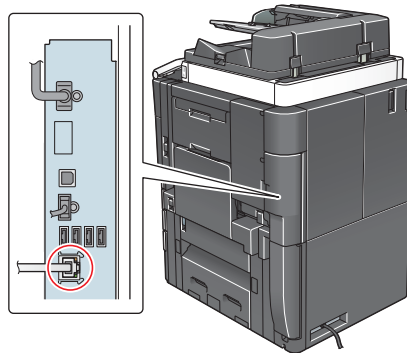

Checking network settings of this machine

Tap [Utility], and select [Device Information]. Check that the IP address is displayed.

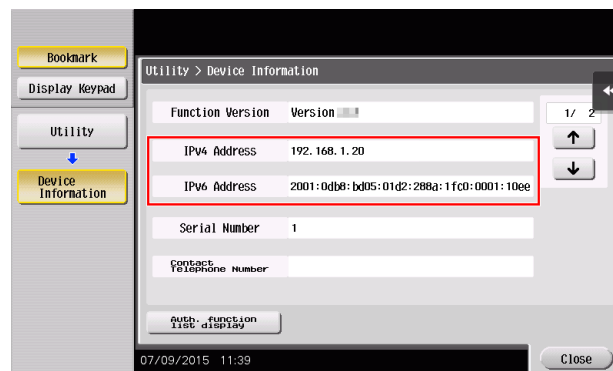

Tips

- In general, the default settings are available for network connection; however, some network environments require a change on network settings.
- If no IP address is displayed, you need to set up the network. Tap [Utility], and select [Administrator Settings] - [Network Settings] - [TCP/IP Settings]. Configure the required settings to suit your environment. For details, refer to the User's Guide CD/DVD.

- For information on the default administrator password, refer to the User's Guide CD/DVD.

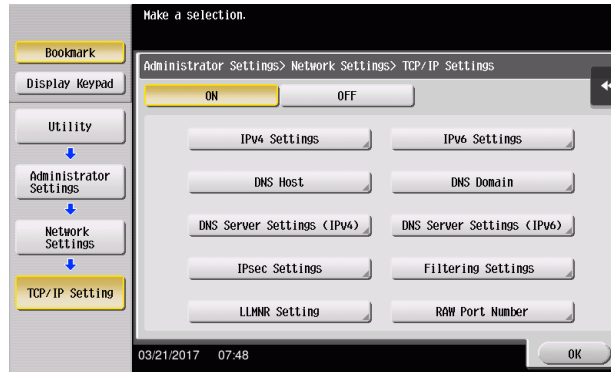

Installing the fax driver

Install the fax driver on the PC by using the installer.

This section describes how to configure the standard print settings.

- ✓ Administrator privileges are required to perform this task.
- 1 Insert the fax driver DVD into the DVD drive of the computer.
 - 2 Select [Agree the Software End User License Agreement.] and [Install printers/MFPs], and click [Next].
 - 3 Select this machine from the list of detected printers.
 - If multiple identical models are displayed, check the IP address to select an appropriate one. For details on how to check the IP address of this machine, refer to page 3-44.
 - 4 Select [Specify manually.], and check [FAX] is selected.
 - 5 Click [Next].
 - 6 Click [Install].
 - 7 Click [Finish].

Sending data

- 1 Create data to be sent using application software.
- 2 From the [File] menu, select [Print].
- 3 Select the fax driver of this machine, and click [Print].
 - Clicking [Preferences] can change the setting of the printer driver as required.
 - If user authentication is enabled in this machine, specify the required data such as the user name and password.
- 4 Enter the destination [Name] and [FAX Number].
 - To send data to more than one destination, repeat this step.
 - Clicking [Add from Address Book] can retrieve the registered destinations of this machine.
- 5 Click [OK].

3.4 Copy function

Basic operations

The following describes the basic operations to make a copy.

- 1 If user authentication is enabled, the login screen appears. Tap the entry area or keyboard icon to enter the required information, then tap [Login] or press the **Access** key.
 - If IC card or biometric authentication is enabled, refer to page 3-48.

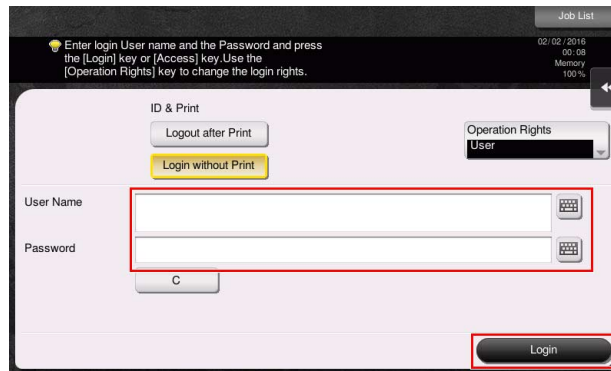

- 2 Load the original.

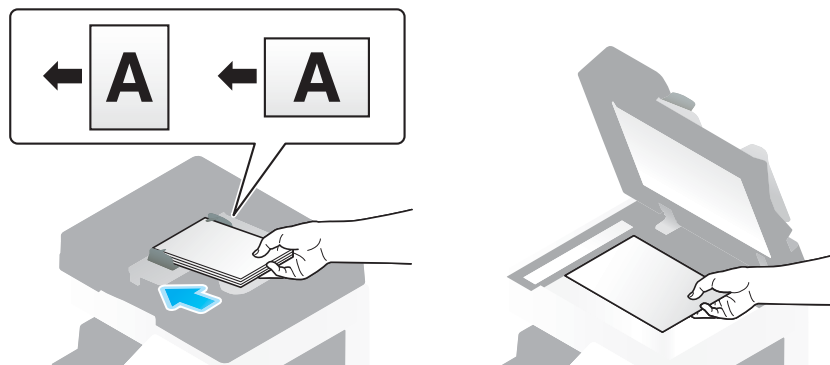

- 3 Tap [Copy].

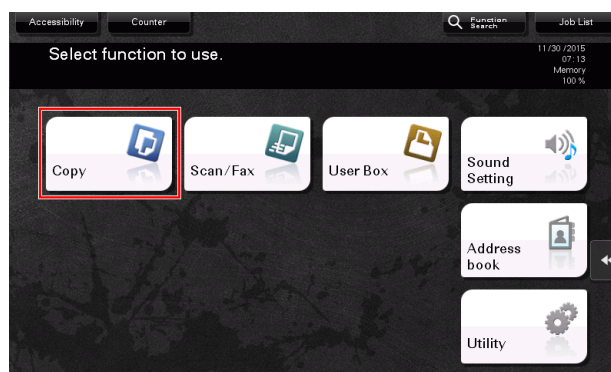

4 Check the basic settings.

- Check the output image configured as specified while viewing the output illustrations displayed on the **Touch Panel**.
- Tapping [Check Setting] can check detailed settings.

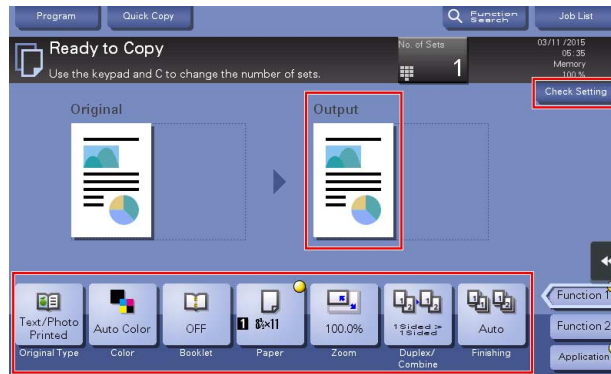

- To change the setting, tap the desired key on the **Touch Panel**.

Settings	Description
[Original Type]	Specify the original type of the original.
[Color]	Specify the color to output an image.
[Booklet]	The pages in the original data are arranged and spread in a booklet format and printed on both sides of sheets.
[Paper]	Specify the output paper.
[Zoom]	Specify the zoom ratio.
[Duplex/Combine]	Specify double-sided copying or combine copying.
[Finishing]	Configure the offset, punch, or staple setting for output paper.
[Density]	Adjust the copy density.

5 Tap the input area for entering the number of copies.



- 6 Enter the number of copies using the **Keypad**, and press the **Start** key.

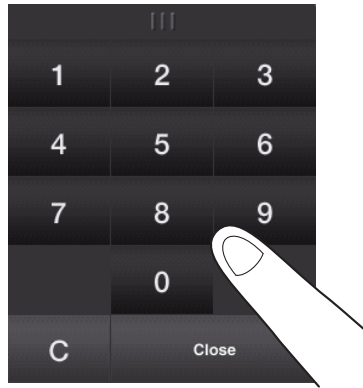

User authentication

You can perform authentication by user or group in this machine.

Installing optional units enables IC card, NFC, or biometric authentication.

If IC card or NFC authentication is enabled, place the IC card or Android terminal on the card reader of the authentication unit.

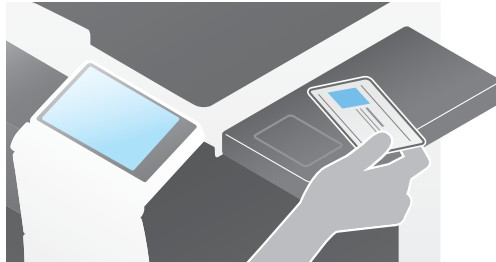

If biometric authentication is enabled, put your finger on the finger vein reader of the authentication unit.



3.5 Registering a destination

3.5.1 Registering an address book

The fax and scan-to-send functions can register the frequently used destinations as address books. This section explains an example to register an address book to which a fax is sent.

Using the Control Panel to register an address book - Registration from [Utility]

Select a destination type, and register destination information.

- 1 Tap [Utility], and select [One-Touch/User Box Registration] - [Create One-Touch Destination] - [Address Book].
- 2 Select the type of the destination you want to register.

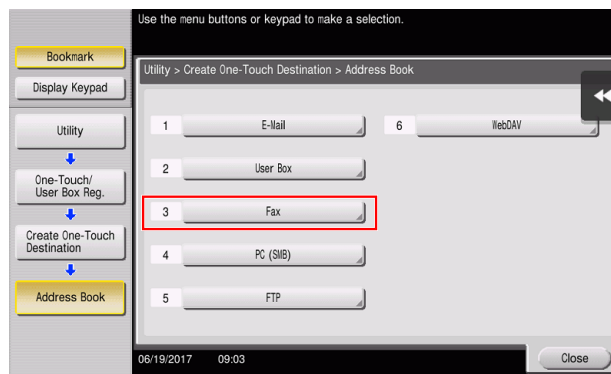

- 3 Tap [New].

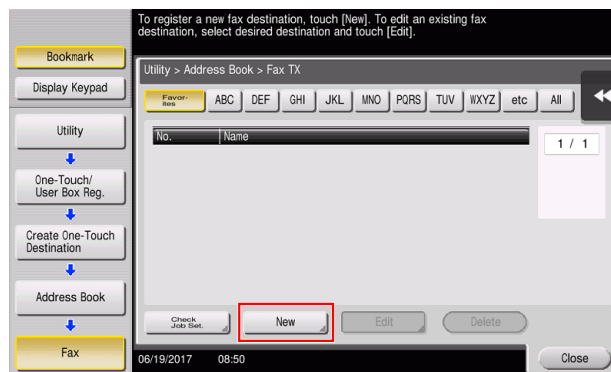

- 4 Enter the destination name you want to register.
- For [Name], enter the destination name using the displayed keyboard.
 - For [Sort Character], enter the same name as [Name].

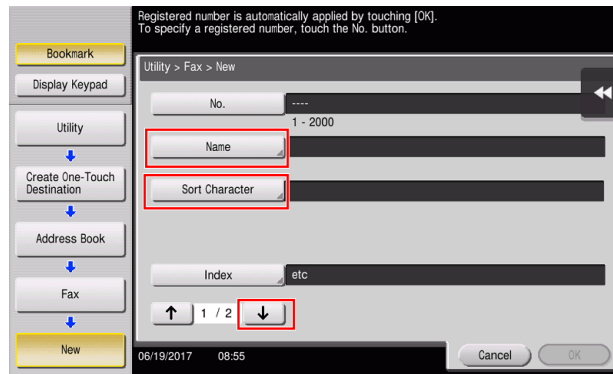

- This sets the appropriate index for the name, which you entered into [Name], to [Index]. To change the setting, tap [Index].
- Entry items and the number of setting screens vary depending on the destination type. Use [↑] or [↓] to switch setting screens while entering the required items. For information on entry items, refer to page 3-57.

- 5 Enter the fax number.

- Tap [Display Keypad] to display the **Keypad**, and enter the fax number.

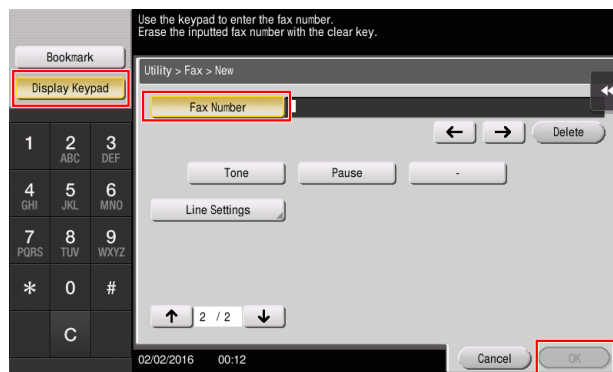

- 6 Tap [Close].

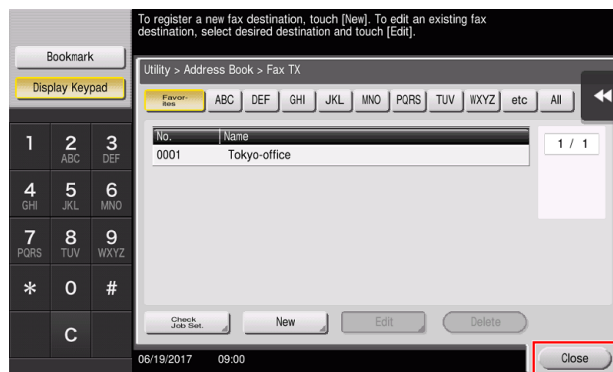

Using the Control Panel to register an address book - Registration from [Address book]

Select a destination type, and register destination information.

- 1 Tap [Address book].

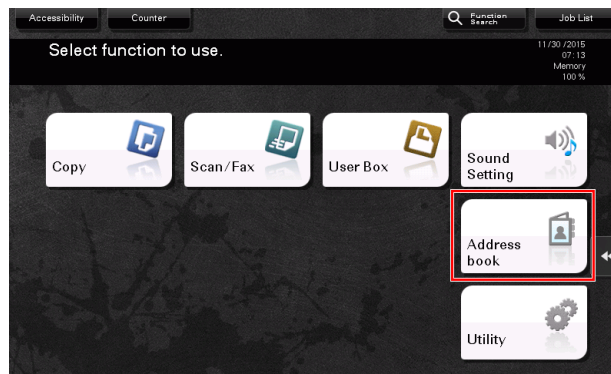

- 2 Tap [New].

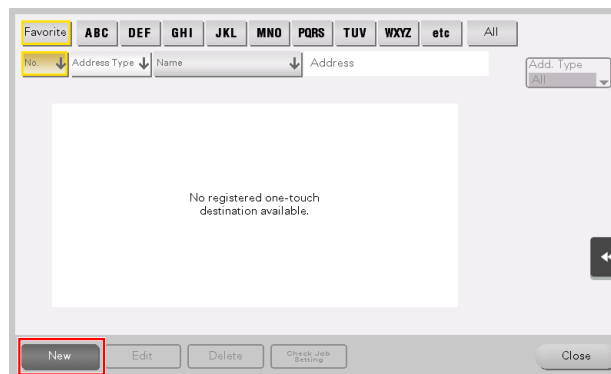

- 3 Select the type of the destination you want to register.

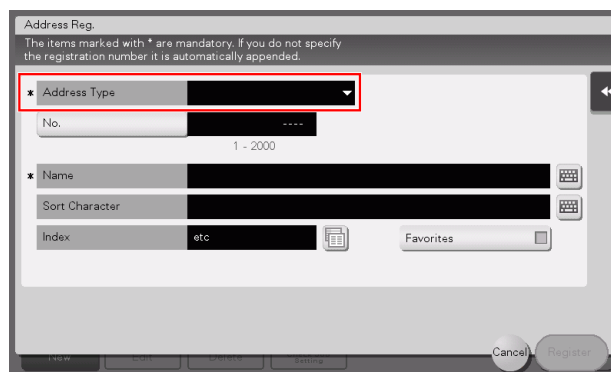

- 4 Enter the destination name you want to register.
- For [Name], enter the destination name using the displayed keyboard.
 - For [Sort Character], enter the same name as [Name].

The screenshot shows the 'Address Reg.' form with the following fields and options:

- Address Type:** Fax
- No.:** [Redacted] (Range: 1 - 2000)
- Name:** [Redacted] (highlighted with a red box)
- Sort Character:** [Redacted] (highlighted with a red box)
- Index:** etc
- Fax Number:** [Redacted]

Buttons at the bottom include 'Cancel' and 'Register'.

- This sets the appropriate index for the name, which you entered into [Name], to [Index]. To change the setting, tap the [Index] field.
- Entry items and the number of setting screens vary depending on the destination type. For information on entry items, refer to page 3-57.

- 5 Enter the fax number.

The screenshot shows the 'Address Reg.' form with the following fields and options:

- Fax Number:** [Redacted] (highlighted with a red box)
- TX Method:** Overseas TX, ECM, V.34 (checked)
- Check Dst. and Send:** [Redacted]
- Select Line:** No Selection, Line 1, Line 2

Buttons at the bottom include 'Cancel' and 'Register' (highlighted with a red box).

- 6 Tap [Close].

The screenshot shows the 'Favorite' list with the following columns: No., Address Type, Name, Address, Add. Type.

No.	Address Type	Name	Address	Add. Type
PA0001	Fax	tokyo-office	03-124-5678	Fax

Buttons at the bottom include 'New', 'Edit', 'Delete', 'Check Job Setting', and 'Close' (highlighted with a red box).

Using the Control Panel to register an address book - Registration in scan/fax mode

Select a destination type, and register destination information.

- 1 Display the scan/fax screen.
- 2 Tap [Address Reg.].

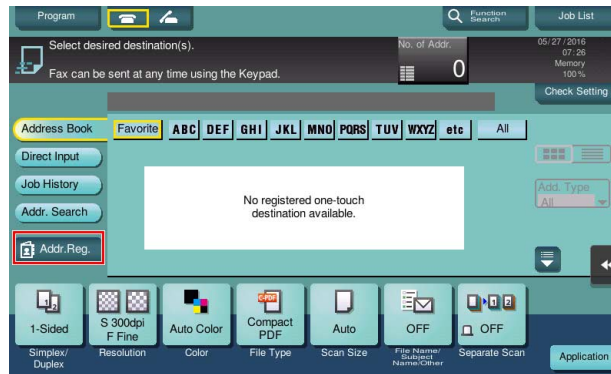

- 3 Tap [New].

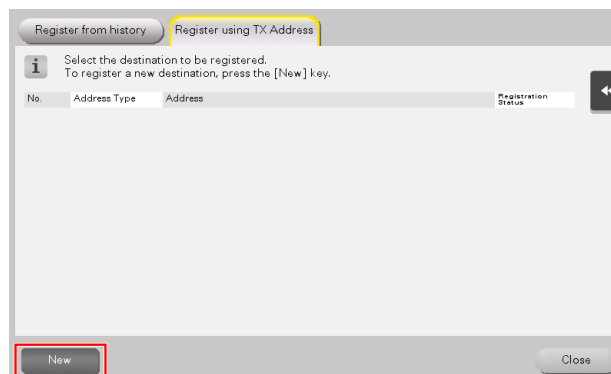

- 4 Select the type of the destination you want to register.

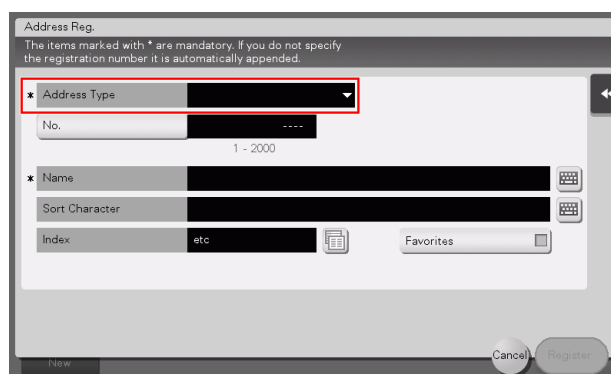

- 5 Enter the destination name you want to register.
- For [Name], enter the destination name using the displayed keyboard.
 - For [Sort Character], enter the same name as [Name].

The screenshot shows the 'Address Reg.' form with the following fields and options:

- Address Type:** Fax (selected)
- No.:** [Empty field]
- Name:** [Red box highlights this field]
- Sort Character:** [Red box highlights this field]
- Index:** etc
- Fax Number:** [Empty field]

Buttons at the bottom: New, Cancel, Register.

- This sets the appropriate index for the name, which you entered into [Name], to [Index]. To change the setting, tap the [Index] field.
- Entry items and the number of setting screens vary depending on the destination type. For information on entry items, refer to page 3-57.

- 6 Enter the fax number.

The screenshot shows the 'Address Reg.' form with the following fields and options:

- Fax Number:** [Red box highlights this field]
- TX Method:** Overseas TX, ECM, V.34 (checked)
- Check Dst. and Send:** [Empty field]
- Select Line:** No Selection, Line 1, Line 2

Buttons at the bottom: New, Cancel, Register.

- 7 Tap [Close].

The screenshot shows the 'Address registration completed' screen with the following elements:

- Register from history** / **Register using TX Address** (selected)
- Address registration completed.**
- Registration status table:**

No.	Address Type	Address	Registration status

Buttons at the bottom: New, Close.

Registration by Direct Input

- The destination entered by using the [Direct Input] button can be registered before sending data as well. To register the destination, tap [Address Reg.] after entering the destination using direct input, and then select the destination.

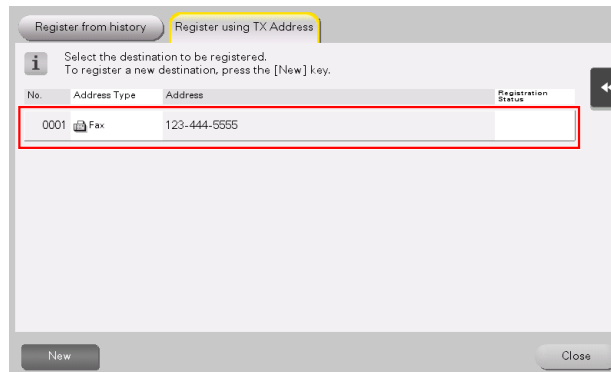

What is an index?

- This is used as an index of a registered destination. Tap the Index key to narrow down a target destination.
- If [Favorite] is selected as an index, the destination appears in the basic screen of the transmission screen after it has been registered in the address book; enabling the user to easily select a destination.

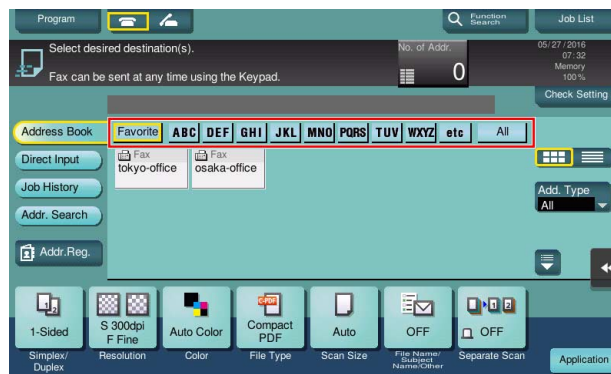

Using a computer to register a one-touch destination

In addition to using the **Control Panel**, address books can be registered from a computer using the utility software, **Web Connection**.

- 1 Check the IP address of this machine
 - Tap [Utility], and select [Device Information]. Check that the IP address is displayed.

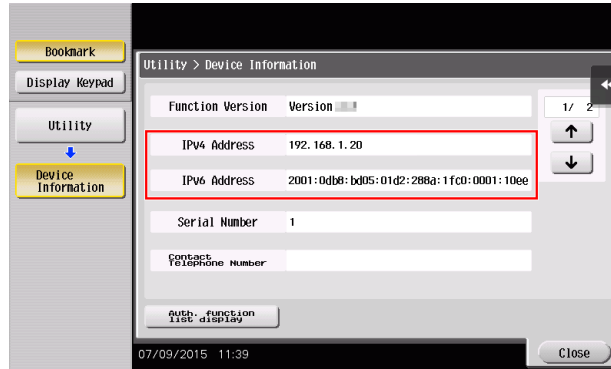

- If no IP address is displayed, you need to configure the network. For details, refer to the User's Guide CD/DVD.

- 2 Start a Web browser, enter the IP address of this machine into the URL field, then press the [Enter] key.
 - For "http://192.168.1.20/", "192.168.1.20" is an IP address.
 - In the IPv6 environment, enclose the IPv6 address in brackets []. For example, if the IPv6 address of this machine is "fe80::220:6bff:fe10:2f16", type in "http://[fe80::220:6bff:fe10:2f16]/".



- If the login screen appears, enter the required items, then click [Login].

- 3 Select [Store Address] - [Address Book] and click [New Registration].
- 4 Select the type of the destination you want to register, and enter the required information such as the name, fax number, and index.

3.5.2 Information required to register a destination

The items to be entered or the number of screens required to register a destination vary depending on the transmission type. This section describes specific information required to register a destination.

Tips

- Setting items that can generally be used with defaults are omitted in this table.

Item		Description
[E-Mail]	[Name]	Enter the name of the destination to be registered as an address book.
	[E-Mail Address]	Enter the E-mail address used as the destination.
[User Box]	[Name]	Enter the name of the destination to be registered as an address book.
	[User Box]	Select a User Box to be used as a destination.
[Fax]	[Name]	Enter the name of the destination to be registered as an address book.
	[Fax Number]	Enter the fax number of the destination.
[PC (SMB)]	[Name]	Enter the name of the destination to be registered as an address book.
	[User ID]	Enter the login name of the destination computer.
	[Password]	Enter the password required to log in to the computer.
	[Host Address]	Enter the computer name or IP address.
	[File Path]	Enter the folder name to be used as the destination.
[FTP]	[Name]	Enter the name of the destination to be registered as an address book.
	[Host Address]	Enter the address of the FTP server.
	[File Path]	Enter the directory to be used as the destination.
	[User ID]	Enter the user ID required to log in with FTP.
	[Password]	Enter the password required to log in with FTP.
[WebDAV]	[Name]	Enter the name of the destination to be registered as an address book.
	[User ID]	Enter the user ID required to log in with WebDAV.
	[Password]	Enter the password required to log in with Web-DAV.
	[Host Address]	Enter the address of the WebDAV server.
	[File Path]	Enter the directory to be used as the destination.

3.5.3 Registering a group

Several address books can be registered as a group.

This function is useful when you have jobs involving sending data to specified members at periodic intervals.

Registering a new group

- 1 Tap [Utility], and select [One-Touch/User Box Registration] - [Create One-Touch Destination] - [Group].
- 2 Tap [New].

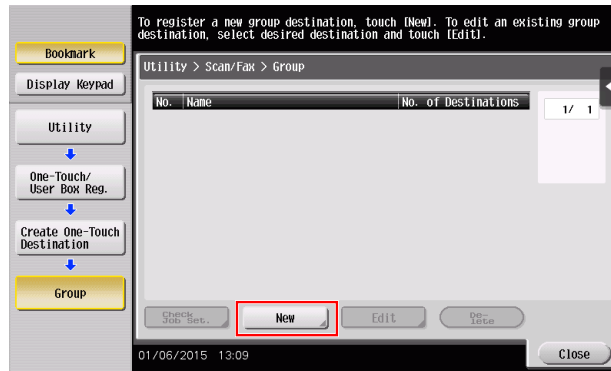

- 3 Enter the destination name you want to register.
 - For [Name], enter the destination name using the displayed keyboard.
 - For [Sort Character], enter the same name as [Name].

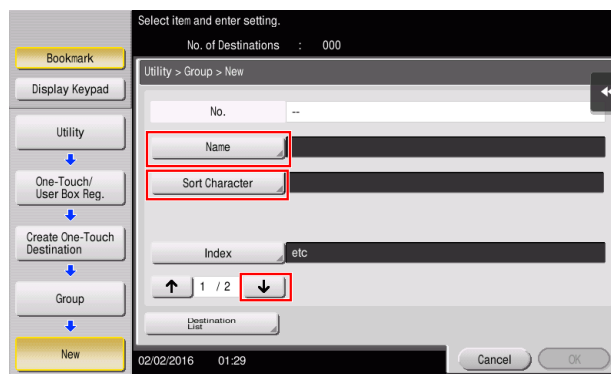

- This sets the appropriate index for the name, which you entered into [Name], to [Index]. To change the setting, tap [Index].

4 Select destinations to be grouped.

Display and select the target address book on the destination selection screen. The following two methods can be used to search for a destination.

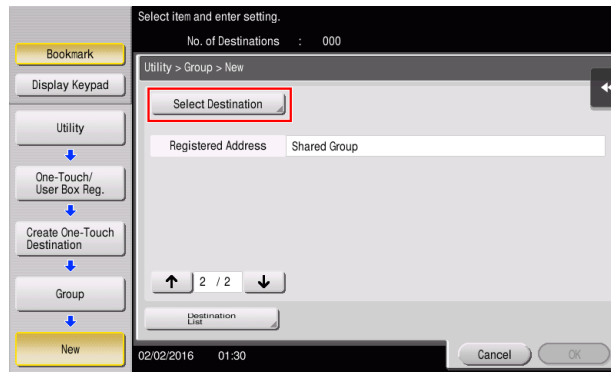

→ [Index]: Searches for the target destination name using an index.

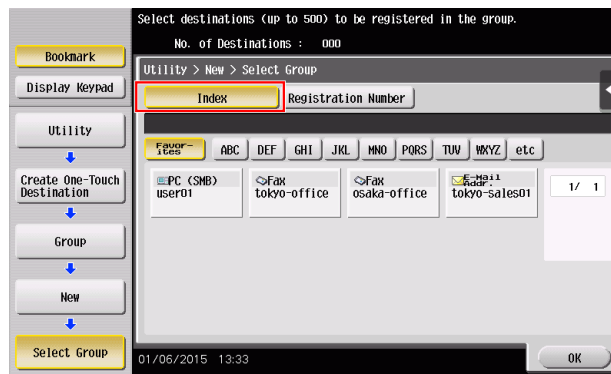

→ [Registration Number]: Searches for the target destination using a registration number.

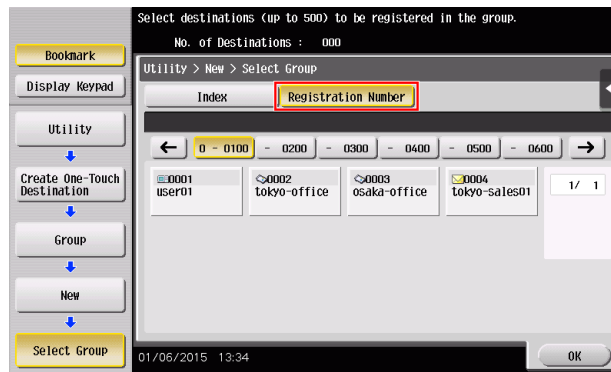

5 Repeat Step 4 until you select all address books to be grouped.

3.5.4 Retrieving a registered destination

Retrieve an address book or group to specify it as a destination to which data is sent.

Retrieving a destination

- 1 Tap [Scan/Fax].

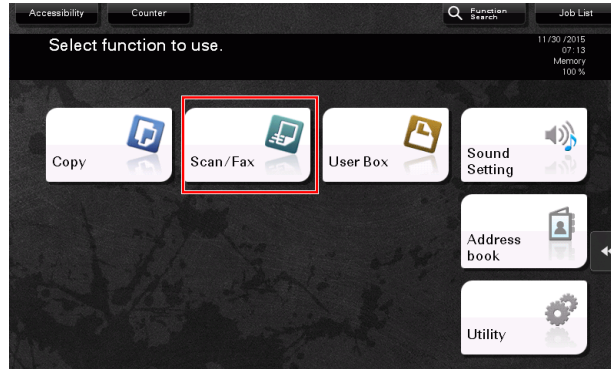

The destinations, which are categorized into [Favorite] when registering indexes, are displayed on the basic screen.

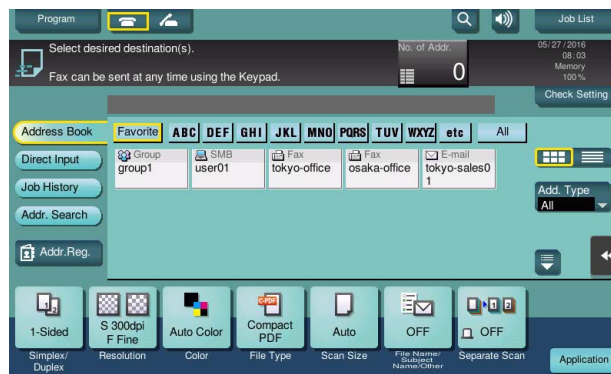

2 Narrow down destinations using index and address type.

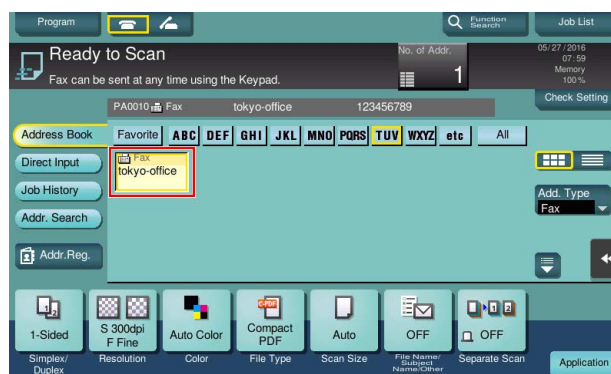
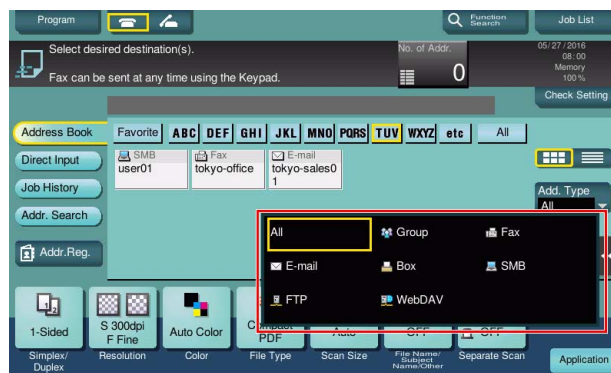
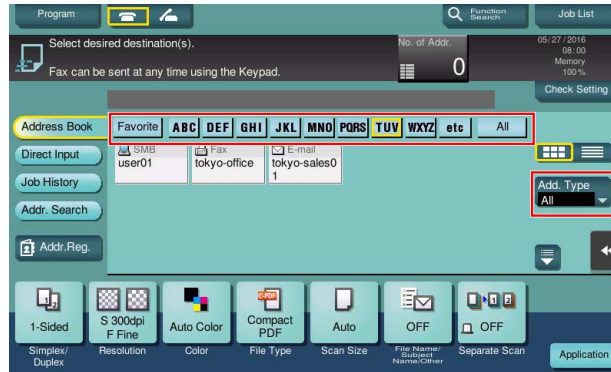

Specifying a destination

In addition to retrieving a registered destination, a destination can be specified in various methods.

Method	Description
[Direct Input]	Directly enter a destination using the keyboard screen or Keypad .
[Job History]	Specify a target destination in the job history (latest five destinations) on the scan/fax screen.
[Addr. Search]	Retrieves destination candidates by the prefix search function using the name (registered destination name) or address (fax number, E-mail address, or computer name). This function is convenient when there are too many registered destinations.



Reference

For details, refer to the User's Guide CD/DVD.

3.6 Using a USB memory device

3.6.1 Printing data in a USB memory device

Data saved in the USB memory device can be printed. This function is useful when printing data created on a computer that is not connected to the network.

Available USB memory device

- Compatible with USB Version 2.0/1.1 interface
- Formatted in FAT32
- Without security function added, or with security function that can be turned off as required
- There is no upper limit for the memory size.

Available printing file types

- PDF, Compact PDF, JPEG, TIFF, XPS, Compact XPS, OOXML (.docx/.xlsx/.pptx), and PPML (.ppml/.vdx/.zip)
- Other file types are not supported on this machine.

Printing data

- 1 Insert a USB memory device into the USB port of the machine.

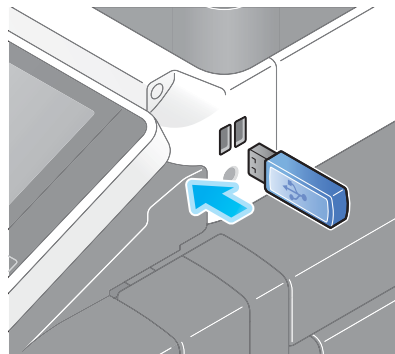

NOTICE

Use the USB connector on the side that is near the **Control Panel**.

Do not use a USB device other than a flash-memory device.

- 2 Tap [Print a document from External Memory.].

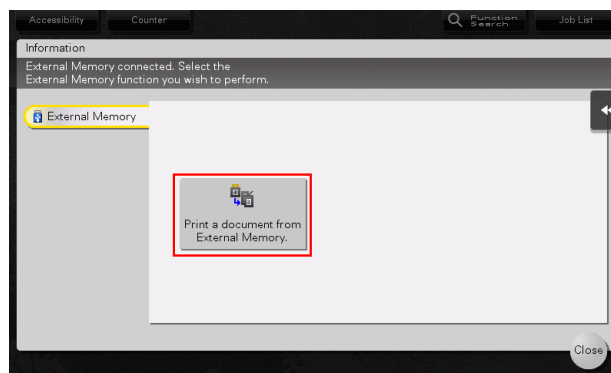

- 3 Select data to be printed, and tap [Print].

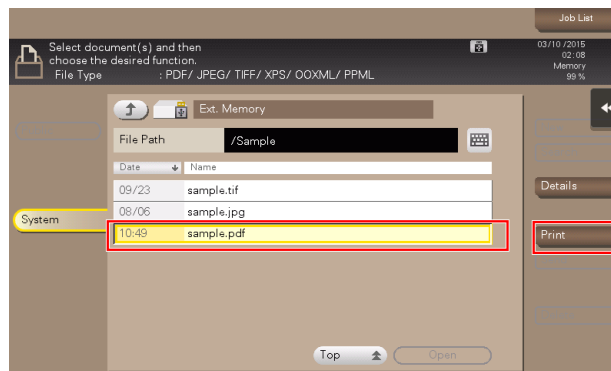
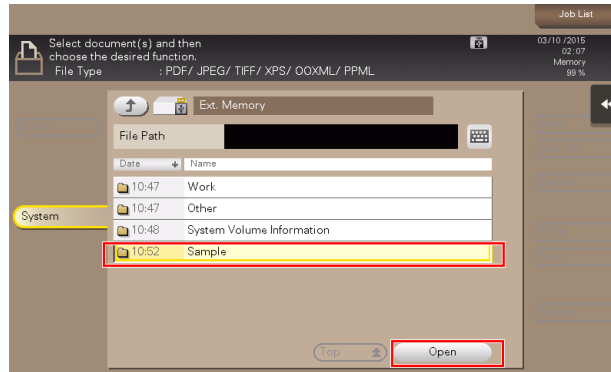

- 4 Check print settings.

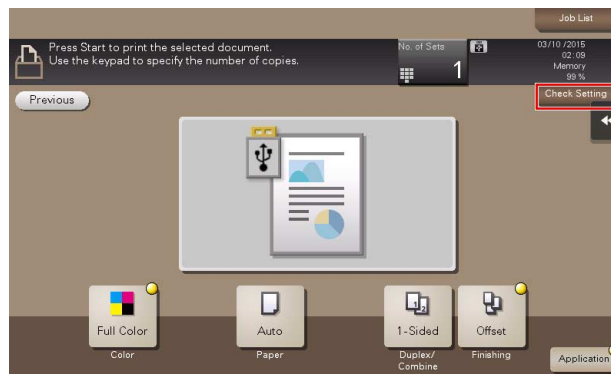

- 5 Press the **Start** key.



NOTICE

Do not disconnect the USB memory device during data printing.

3.6.2 Saving the scanned data in the USB memory device (External memory)

The data scanned on this machine can be saved to the USB memory device, so it is convenient when printing data created on a computer that is not connected to the network.

Available USB memory device

- Compatible with USB Version 2.0/1.1 interface
- Formatted in FAT32
- Without security function added, or with security function that can be turned off as required
- There is no upper limit for the memory size.

Specifying functions to be permitted for external memory

Change the settings to save documents in the USB memory device.

- 1 Tap [Utility], and select [Administrator Settings] - [System Settings] - [User Box Settings].
→ For information on the default administrator password, refer to the User's Guide CD/DVD.

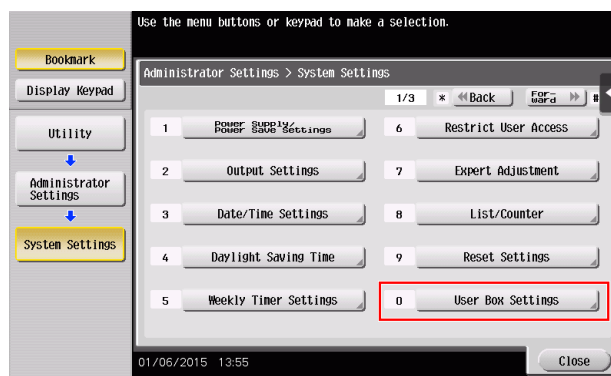

- 2 Tap [External Memory Functional Settings].

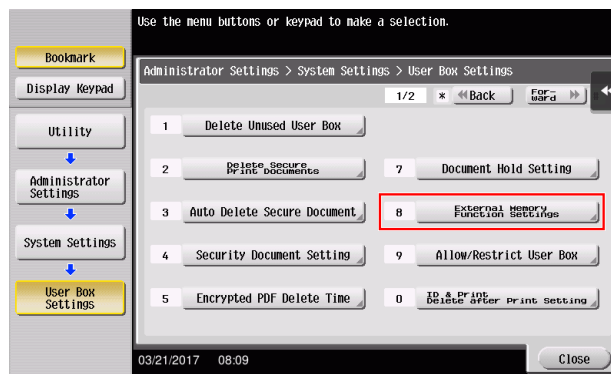

- 3 Select [Save Document] and [ON]. Tap [OK].

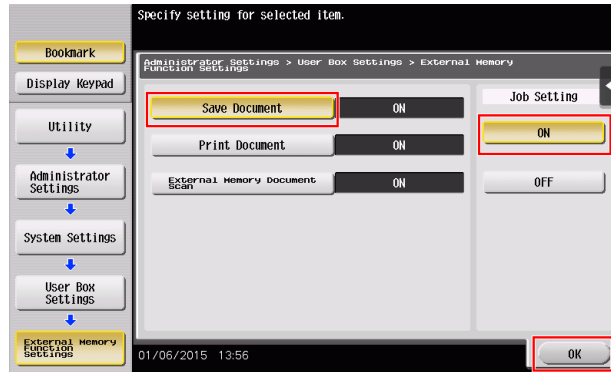

Saving data in the USB memory device

- 1 Load the original.

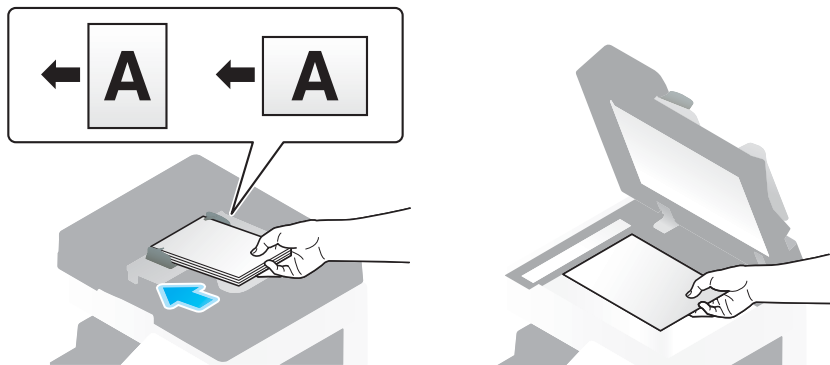

- 2 Connect a USB memory device to this machine.

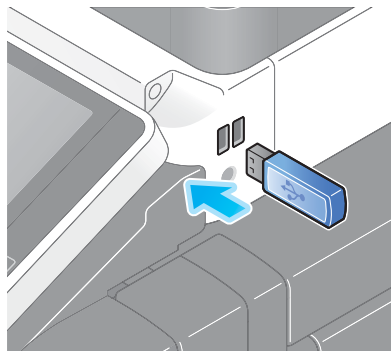

NOTICE

Use the USB connector on the side that is near the **Control Panel**.

Do not use a USB device other than a flash-memory device.

- 3 Tap [Save a document to External Memory.].

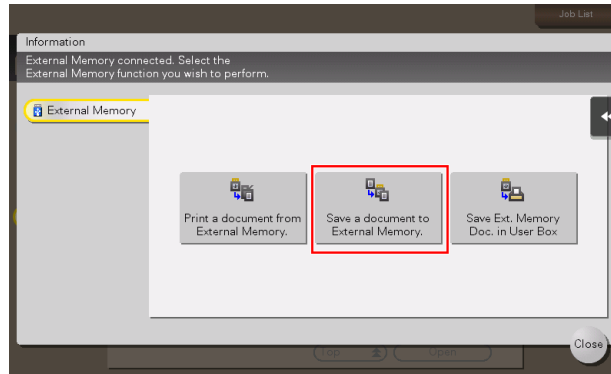

- 4 Check the file name.

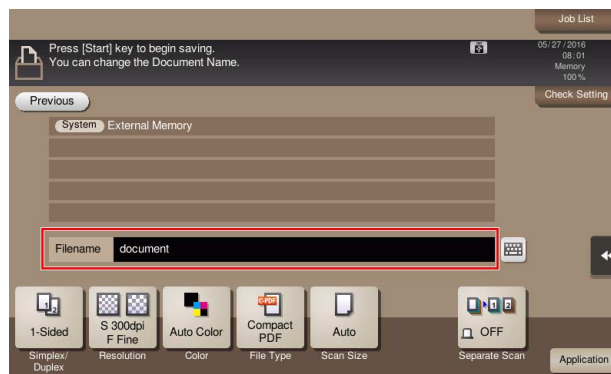

- 5 If necessary, check the setting to save data.
- Tap [Check Setting] to check the setting.
 - To change a file name, tap the file name or keyboard icon.

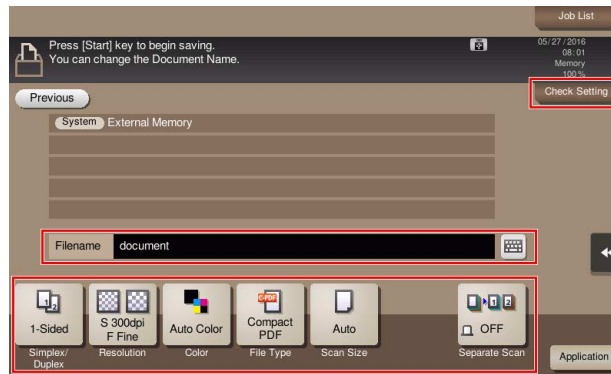

- You can also check the setting using the keys displayed on the **Touch Panel**.
- To change the setting, tap the desired key on the **Touch Panel**.

Settings	Description
[Simplex/Duplex]	Select whether to scan one or both sides of the original.
[Resolution]	Specify the scanning resolution.
[Color]	Select whether to scan the original in color or black and white mode.
[File Type]	Select the type of the file to save scanned data.
[Scan Size]	Specify the size of the original to be scanned.
[Separate Scan]	If all pages of the original cannot be loaded into the ADF at one time, change the setting to ON. You can load the pages of the original in several batches and handle them as one job. For details on using the separate scan function, refer to the User's Guide CD/DVD.

- 6 Press the **Start** key.



NOTICE

Do not disconnect the USB memory device during data saving.

3.7 Using the guidance function

3.7.1 Guidance screen

This machine provides the guidance function to display the description of a function on the screen and view an operation procedure with moving images.

If you have any questions during operation, try to use this guidance function.

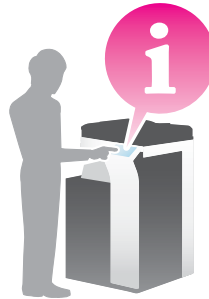

Getting help on the currently displayed screen:

Select [Function] on the Help Menu to display the guidance screen.

- 1 Press the **Guidance** key (default: Register key **2**).

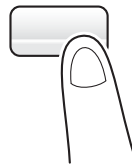

- 2 Select a menu.

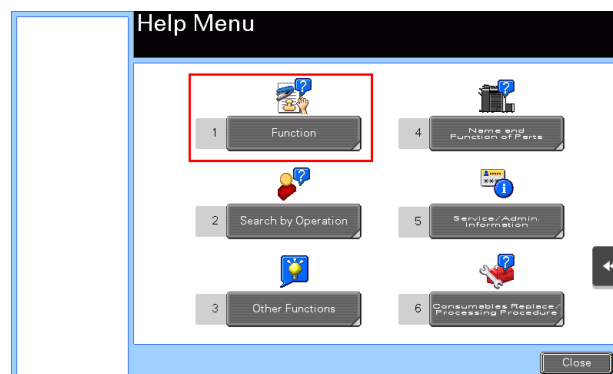

3 Narrow down the information you want to know.

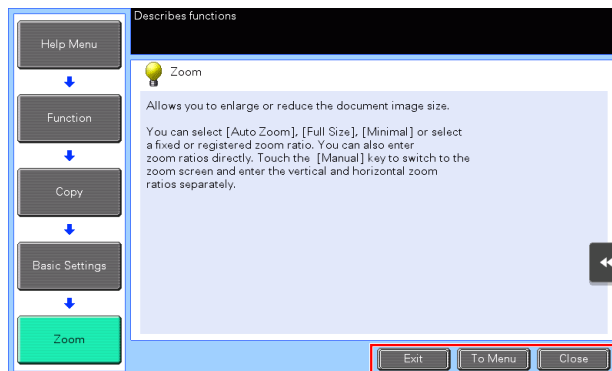
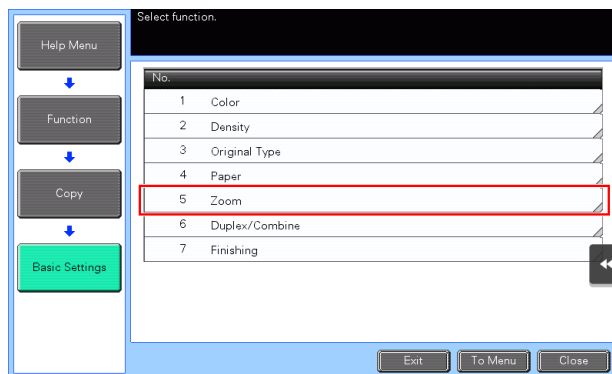
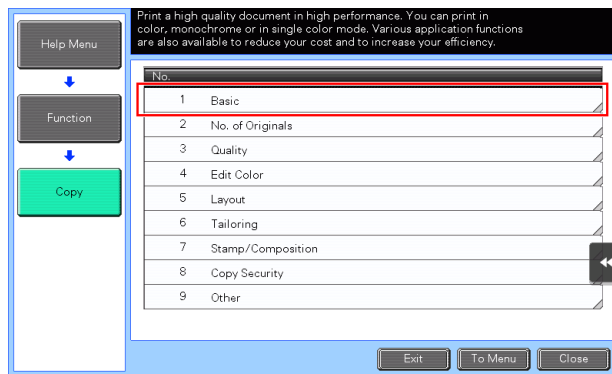
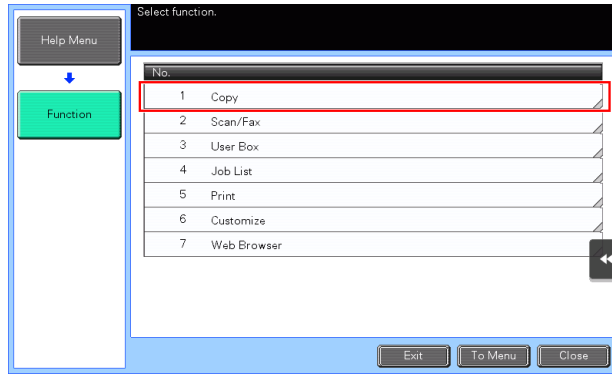

Name	Description
[Exit]	Returns to the screen that is displayed before the guidance screen.
[To Menu]	Returns to the Help Menu.
[Close]	Returns to the preceding screen.

Getting help on the desired function or procedure:

Open the Help Menu, and select a menu depending on an objective to display the guidance screen.

- 1 Press the **Guidance** key (default: Register key **2**).

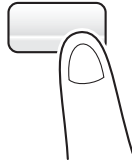

- 2 Select a menu.

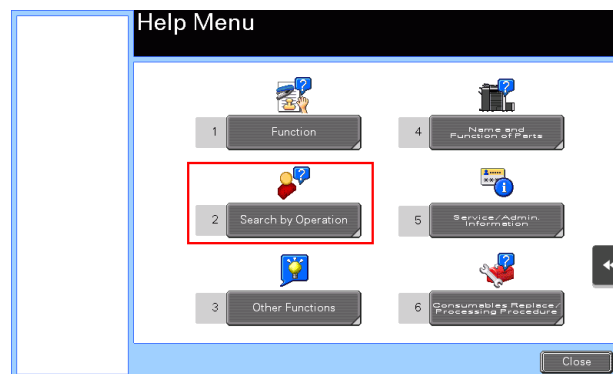

3 Narrow down the information you want to know.

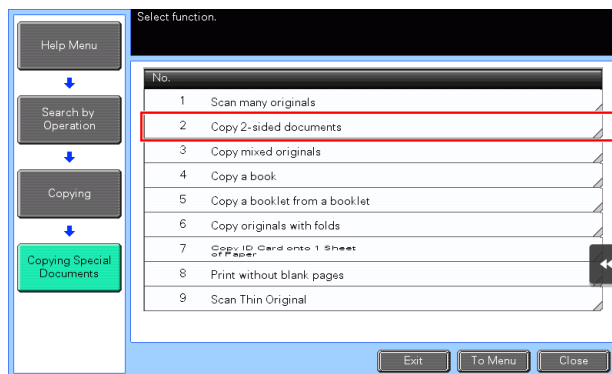
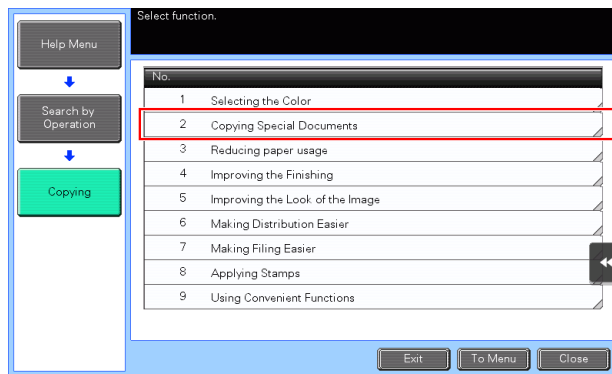
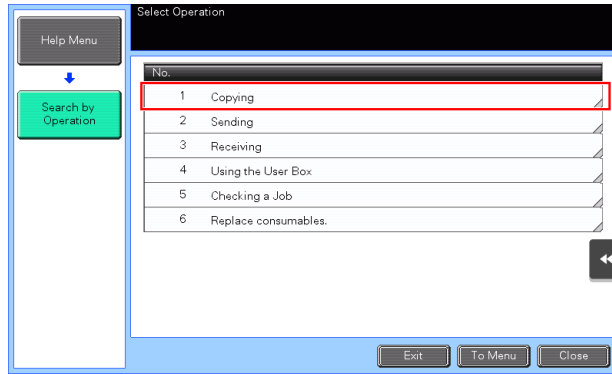

- 4 Tapping [Go to function] opens the setting screen of a target function, enabling you to configure the settings immediately.

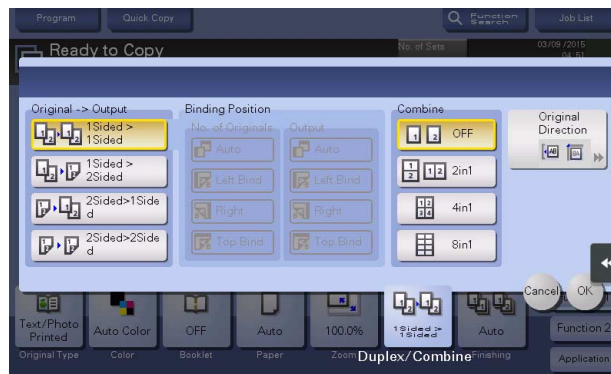
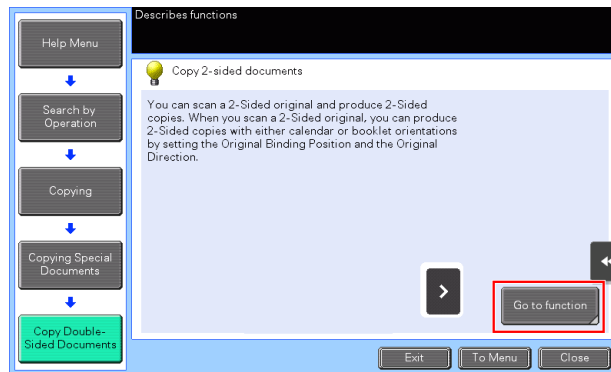

Help Menu list

The Help Menu provides the following information:

Name	Description
[Function]	Tap this button to display the guidance menu that has been sorted according to the function names to be displayed in the screen.
[Search by Operation]	Tap this button to display operation examples and explanations of this machine sorted by function.
[Other Functions]	Tap this button to display the guidance menu of the functions and settings that make it easier to use this machine.
[Name and Function of Parts]	Tap this button to check the name or function of each part of this machine.
[Service/Admin. Information]	Tap this button to display the service or administrator information, administrator name, extension number, and E-mail address.
[Consumables Replace/Processing Procedure]	Tap this button to check how to replace consumables or dispose of punch scraps.

3.8 Using the [Quick Security] function

3.8.1 [Quick Security]

[Quick Security] allows you to configure the settings for enhancing the security level of this machine. In order to use this machine securely, we recommend that you use the [Quick Security] function to configure the settings.

Required settings

- 1 Tap [Utility], and select [Administrator Settings] - [Forward] - [Security Settings] - [Forward] - [Quick Security Setting].

→ For information on the default administrator password, refer to the User's Guide CD/DVD.

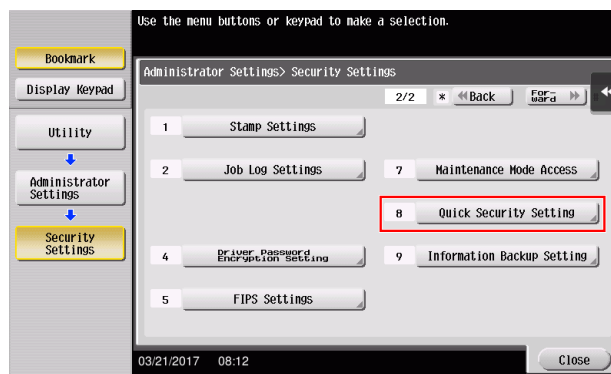

- 2 Configure a setting for each option.



Settings	Description
[Administrator Password]	Change the administrator password of this machine.
[USB Enable Settings]	Specify whether to permit a function that requires the USB Port .
[Password Rules]	Configure whether to enable the password rules. Once you enable it, the number of characters and text types that are available for passwords is restricted.
[Quick IP Filtering]	Allows you to restrict the devices that can access this machine using the IP address (IPv4/IPv6). The range of IP addresses for which access is to be restricted is specified automatically.
[PSWC Setting]	Select whether to use Web Connection .
[Security Warning Display Setting]	Select whether to display the security warning screen if the administrator password remains set to the default or if password rules are not satisfied.

- When [Security Warning Display Setting] is set to [ON], the following security warning screen appears if the administrator password remains set to the default or if password rules are not satisfied. Tap [Set Now] to configure the [Quick Security] function.



Tips

- You can specify whether to display the [Quick Security] key on the main menu. This key is not displayed in the default state. To display the key, tap [Utility], and select [Administrator Settings] - [System Settings] - [Custom Display Settings] - [Main Menu Default Settings] - [Main Menu Key].
- In some areas, the [Quick Security] key is displayed on the main menu by default. However, if [Administrator Password] in [Quick Security Setting] was changed from the default setting and [Password Rules] is set to [Enable], the [Quick Security] key will not be displayed on the main menu. To display the key again, tap [Utility], and select [Administrator Settings] - [System Settings] - [Custom Display Settings] - [Main Menu Default Settings] - [Main Menu Key].
- For information on the default administrator password, refer to the User's Guide CD/DVD.

Reference

For details, refer to the User's Guide CD/DVD.

4

Advanced Functions

4 Advanced Functions

4.1 Using advanced functions

4.1.1 What are advanced functions?

Various functions for further enhancement of the MFP operability are expressed as advanced functions in this manual.

This machine provides the following advanced functions.



Tips

- To use an advanced function, you need to register **i-Option** or associate with the **My Panel Manager** application.



Name	Description
PDF processing	You can configure the required settings when converting scanned data to a PDF file. <ul style="list-style-type: none"> • This requires the registration of i-Option LK-102 v3 or i-Option LK-110 v2.
Searchable PDF	You can convert the scanned data to a searchable PDF file. <ul style="list-style-type: none"> • This requires the registration of i-Option LK-105 v4 or i-Option LK-110 v2.
File Type Extension	Supports functions such as a function that converts a file into a DOCX or XLSX type, a function that generates highly-functional and high quality data, and the E-mail RX Print function. <ul style="list-style-type: none"> • This requires the registration of i-Option LK-110 v2.
ThinPrint	Allows you to use this machine as ThinPrint Client (.print Client) when ThinPrint is enabled. <ul style="list-style-type: none"> • This requires the registration of i-Option LK-111.
TPM	You can use the Trusted Platform Module to enhance security by encrypting confidential information such as certificates and passwords of this machine. <ul style="list-style-type: none"> • This requires the registration of i-Option LK-115 v2.
Serverless Pull Printing	Allows you to execute print jobs, which were stored on a device from your computer, from any device in the same serverless pull printing group. <ul style="list-style-type: none"> • This requires the registration of i-Option LK-114.
My Panel	You can customize the Control Panel display of this machine for each user. <ul style="list-style-type: none"> • This requires the association with My Panel Manager.
My Address	You can use the address book for personal use (My Address Book). <ul style="list-style-type: none"> • This requires the association with My Panel Manager.

In addition, this machine supports advanced functions such as the barcode font, unicode font, and OCR font.

**Reference**

For details, refer to the User's Guide CD/DVD.

4.1.2 Association with application

To use the My Panel or My Address function, you need to purchase **My Panel Manager** and enable the target function in the application side.

For details on how to enable such a function, refer to the **My Panel Manager** User's Guide.

4.1.3 Registering the i-Option license

To add an optional function to this machine, you need to purchase **i-Option** and register its license.

**Tips**

- Check that this machine can be connected to the Internet.
- When enabling the **i-Option** function via the Internet, connect this machine to the License Management Server (LMS) through the proxy server used for remote diagnosis. For details on configuring the proxy server used for remote diagnosis, refer to the User's Guide CD/DVD.
- **i-Option LK-110 v2** includes the function licenses for **i-Option LK-102 v3** and **LK-105 v4**. If you purchase **i-Option LK-110 v2**, you do not need to purchase **i-Option LK-102 v3** or **LK-105 v4**.

For details on how to purchase or install an optional unit, contact your service representative.

Preparation flow

The following describes a preparation flow to use advanced functions. For details, refer to the relevant page.

This preparation is not required the second time or subsequent times.

- 1 Enabling the **i-Option** function (Administrator)
 - Enable the **i-Option** function on this machine. For details, refer to page 4-5.
 - If you cannot enable the function above, proceed to steps 2 and 3.
- 2 Registering the **i-Option** license (Administrator)
 - Register the license on a dedicated Web site. For details, refer to page 4-6.
- 3 Enabling the **i-Option** function using the license (Administrator)
 - Enter the license code to enable the function. For details, refer to page 4-8.
- 4 Configuring each function (Administrator)
 - Configure the required settings for each advanced function. For details, refer to page 4-9.

**Reference**

For details on the procedure, refer to the User's Guide CD/DVD.

Enabling the i-Option function

- 1 Prepare at hand the token certificate supplied with **i-Option**.
- 2 Tap [Utility], and select [Administrator Settings] - [Forward] - [License Settings] - [Install License] - [Token Code].
 - For information on the default administrator password, refer to the User's Guide CD/DVD.

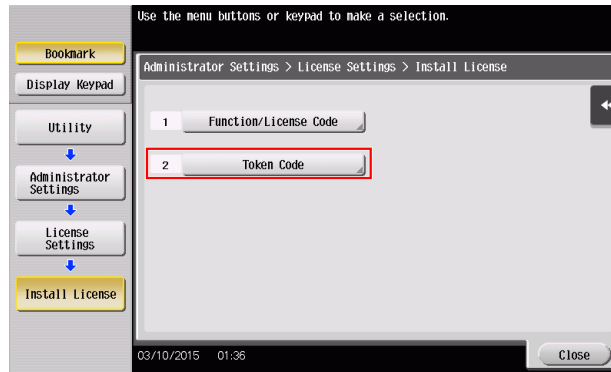

- 3 Enter the token number shown in the token certificate.

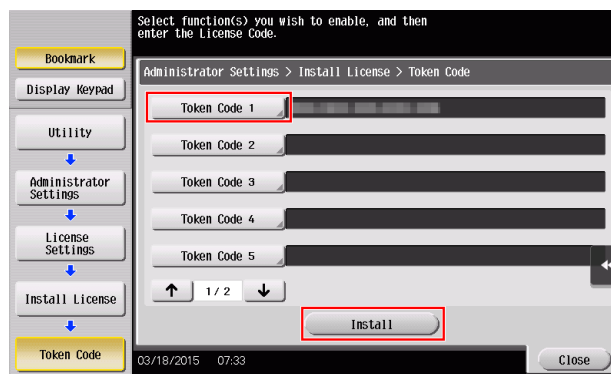

- 4 Select [Yes], then tap [OK].

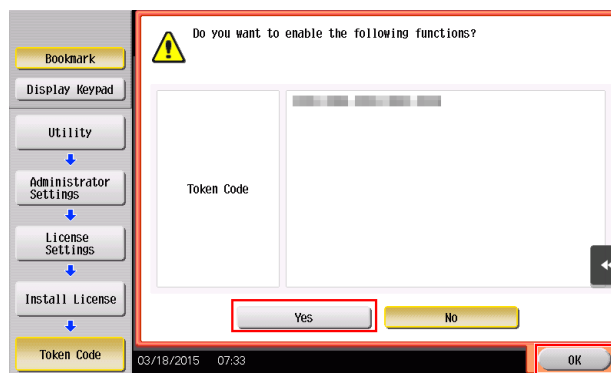

This machine is connected to the Internet to communicate with the License Management Server (LMS), and it restarts automatically.

Registering the i-Option license

Register the request code and the contents of the token certificate on the Web site of the License Management Server (LMS).

This procedure is available when this machine cannot be connected to the Internet.

- 1 Tap [Utility], and select [Administrator Settings] - [Forward] - [License Settings] - [Get Request Code].
→ For information on the default administrator password, refer to the User's Guide CD/DVD.

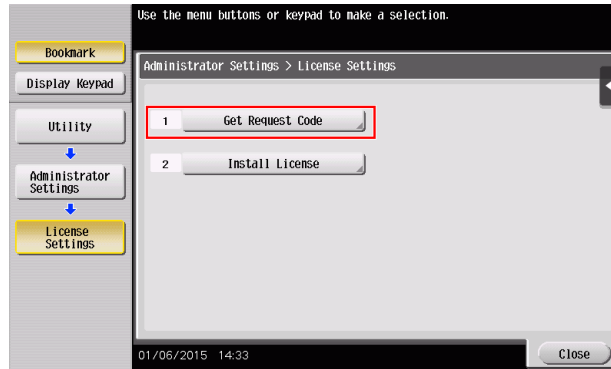

- 2 Tap [Yes] and [OK].

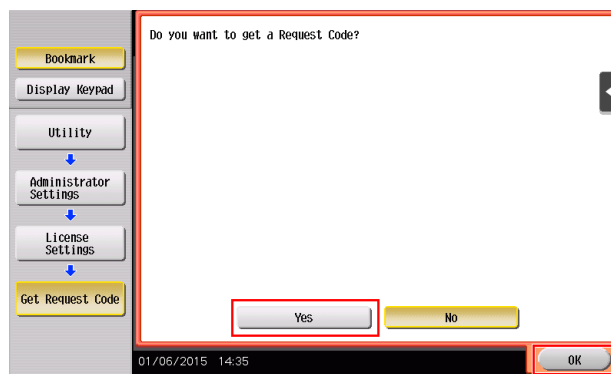

- 3 Tapping [Print] prints the serial number and request code.
→ Prepare at hand the printed serial number, request code, and token certificate supplied with **i-Option**.
- 4 Access the Web site of the License Management Server (LMS). Enter the [MFP Serial Number] and [Request Code], then click [Next].
→ The URL is <https://lms.konicaminolta.com/index.aspx>.

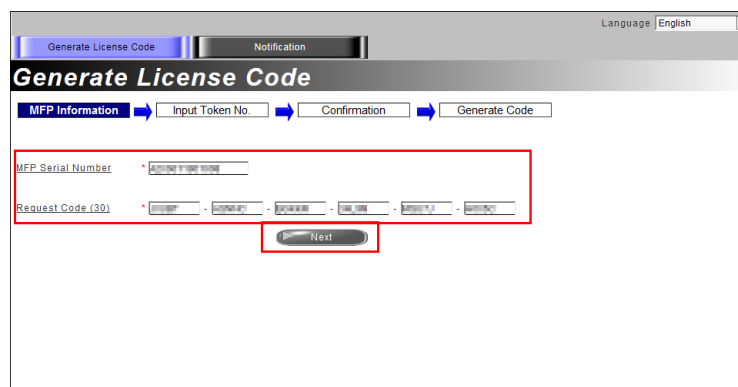

- 5 Enter the [Token Number], select the option you want to register from the [Product Description] list, then click [Next].

The screenshot shows the 'Generate License Code' web interface. At the top, there is a language dropdown set to 'English'. Below the title, there is a progress bar with four steps: 'MFP Information', 'Input Token No.', 'Confirmation', and 'Generate Code'. The 'Input Token No.' step is currently active. Below the progress bar, there are fields for 'MFP Serial Number' and 'Request Code'. The 'Token Number (20)' field is highlighted with a red box and contains the value '12345678901234567890'. The 'Product Description' dropdown menu is also highlighted with a red box and is set to 'i-Option LK-105 v4'. At the bottom, there are two buttons: 'Next' (highlighted with a red box) and 'Back'.

- 6 Confirm the registration contents, then click [Generate License Code].

The screenshot shows the 'Generate License Code' web interface. The progress bar now shows 'Confirmation' as the active step. Below the progress bar, there are fields for 'MFP Serial Number' and 'Request Code'. The 'Generate License Code' button is highlighted with a red box. Below the buttons, there is a table with two columns: 'Token Number' and 'Product Description'. The 'Token Number' field contains '12345678901234567890' and the 'Product Description' field contains 'i-Option LK-105 v4'.

- 7 The license code and function code are issued.

The screenshot shows the 'Generate License Code' web interface. The progress bar now shows 'Generate Code' as the active step. Below the progress bar, there is a message: 'You have successfully generated a License Code. Please save all information for future use.' Below the message, there are fields for 'MFP Serial Number', 'License Code', and 'Function Code'. The 'License Code' field contains a long alphanumeric string. Below the fields, there is a table with two columns: 'Token Number' and 'Product Description'. The 'Token Number' field contains '12345678901234567890' and the 'Product Description' field contains 'i-Option LK-105 v4'. At the bottom, there are three buttons: 'Download', 'Print', and 'Generate Additional License Codes'.

Tips

- The issued license code and function code are required to enable **i-Option**. You should write them down on a memo pad or print them out on paper by clicking [Print].
- You could also store them in your USB memory device. The license code input could be omitted by using a USB memory device to achieve a convenient operation.
- When using a USB memory device, insert the USB memory device and click [Download] to store the license code.

Enabling the i-Option function using the license (Administrator)

Register the license and function codes in this machine.

This procedure is available when this machine cannot be connected to the Internet.

By inputting the codes

- 1 Tap [Utility], and select [Administrator Settings] - [Forward] - [License Settings] - [Install License] - [Function/License Code].
 - For information on the default administrator password, refer to the User's Guide CD/DVD.

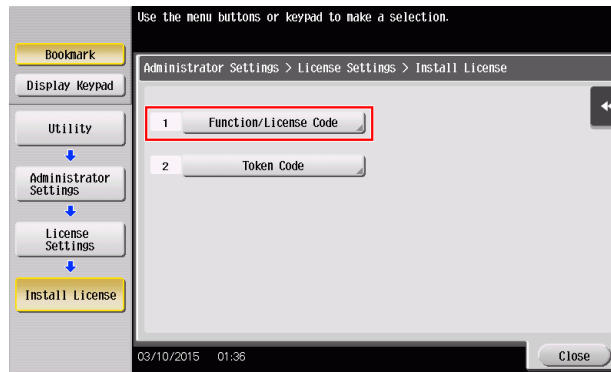

- 2 Enter the license and function codes you wrote down.

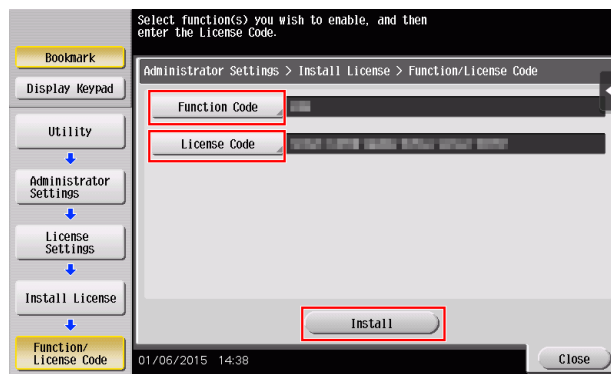

- 3 Select [Yes], then tap [OK].

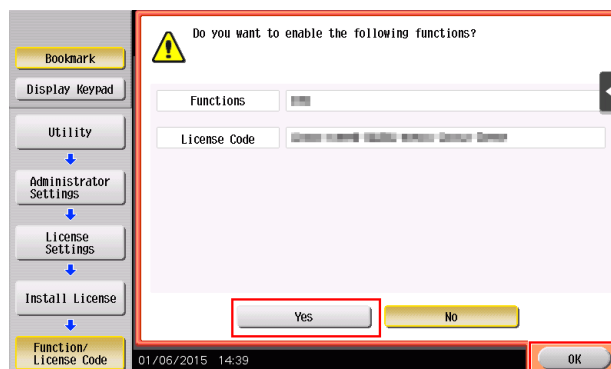

This machine restarts automatically.

By using a USB memory device

- 1 Connect the USB memory device stored with the license code.

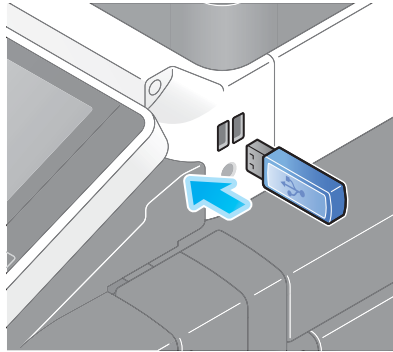

- 2 Tap [Utility], and select [Administrator Settings] - [Forward] - [License Settings] - [Install License from Ext. Memory].

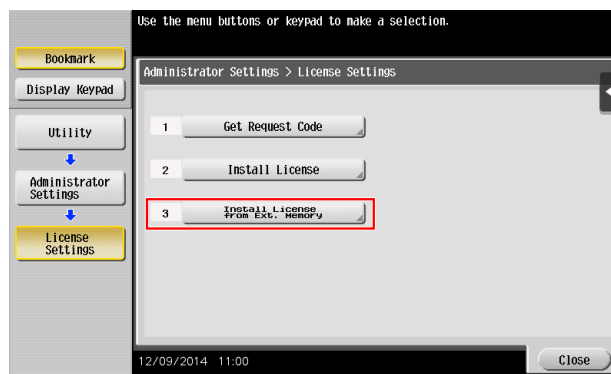

- 3 Select [Yes], then tap [OK].

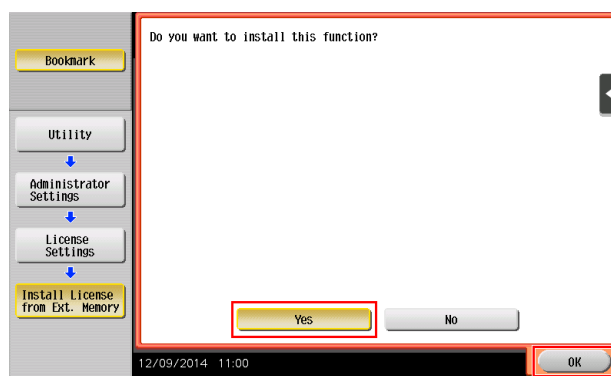

This machine restarts automatically.

Configuring each function

Configure the required settings for each advanced function.

 **Reference**

For details on the required setting items for each advanced function, refer to the User's Guide CD/DVD.

4.2 Using the Web browser function

4.2.1 Required settings and procedures

The Web browser can be used on the **Touch Panel** of this machine.

This section describes how to display and print a Web page on the **Touch Panel** of this machine.



Tips

- Check that this machine can be connected to the Internet.
- When enabling the Web browser function via the Internet, connect this machine to the License Management Server (LMS) through the proxy server used for remote diagnosis. For details on configuring the proxy server used for remote diagnosis, refer to the User's Guide CD/DVD.
- To use the Web browser, administrator settings are required in advance.

Preparation flow

The following describes a preparation flow to use the Web browser function. For details, refer to the relevant page.

This preparation is not required the second time or subsequent times.

- 1** Enabling the Web browser function (Administrator)
 - Enable the Web browser function on this machine. For details, refer to page 4-11.
 - If you cannot enable the Web browser above, proceed to steps 2 and 3.
- 2** Registering the license (Administrator)
 - Register the license on a dedicated Web site. For details, refer to page 4-12.
- 3** Enabling the Web browser using the license (Administrator)
 - Enter the license code to enable the function. For details, refer to page 4-13.

Operation flow

The following describes an operation flow. For details, refer to the relevant page.

- 1 Starting the Web browser
 - For details, refer to page 4-17.
- 2 Displaying Web pages
 - For details, refer to page 4-17.
- 3 Printing the currently displayed page or the linked file
 - For details, refer to page 4-18.



Reference

For details, refer to the User's Guide CD/DVD.

Enabling the Web browser function

- 1 Tap [Utility], and select [Administrator Settings] - [Network Settings] - [Forward] (twice) - [Web Browser Settings] - [Web Browser Usage Settings].
 - For information on the default administrator password, refer to the User's Guide CD/DVD.

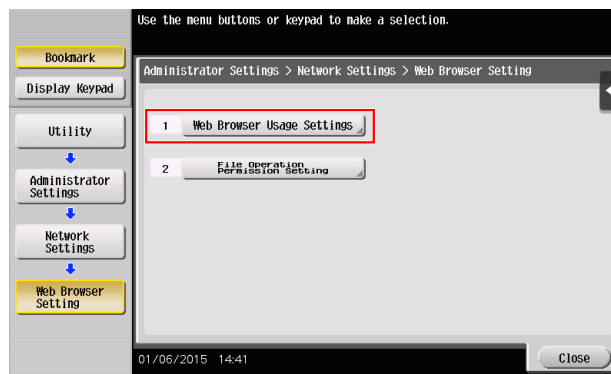

- 2 Select [ON], then tap [OK].

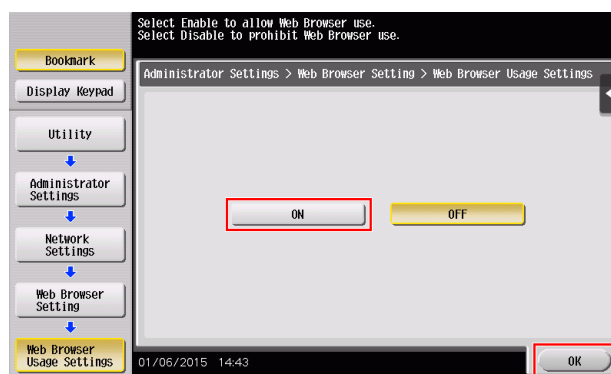

This machine is connected to the Internet to communicate with the License Management Server (LMS), and it restarts automatically.

Registering the license

Register the serial number of this machine on the Web site of the License Management Server (LMS).

This procedure is available when this machine cannot be connected to the Internet.

- 1 Display the serial number of this machine. Tap [Utility], and select [Device Information].

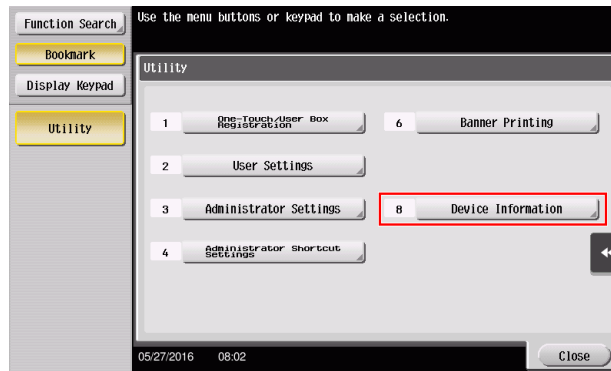

- 2 Write down the serial number of this machine.

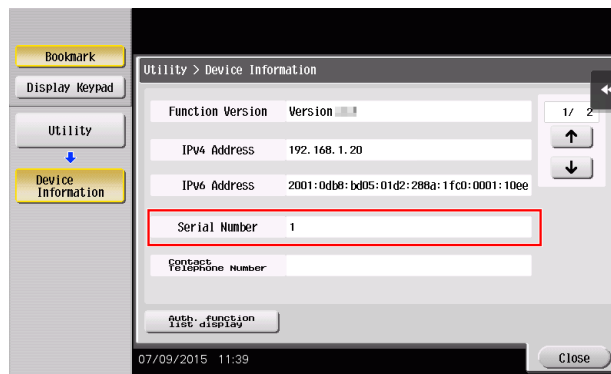

- 3 Access the Web site of the License Management Server (LMS). Enter the [MFP Serial Number], then click [Next].

→ The URL is <https://lms.konicaminolta.com/activate>.

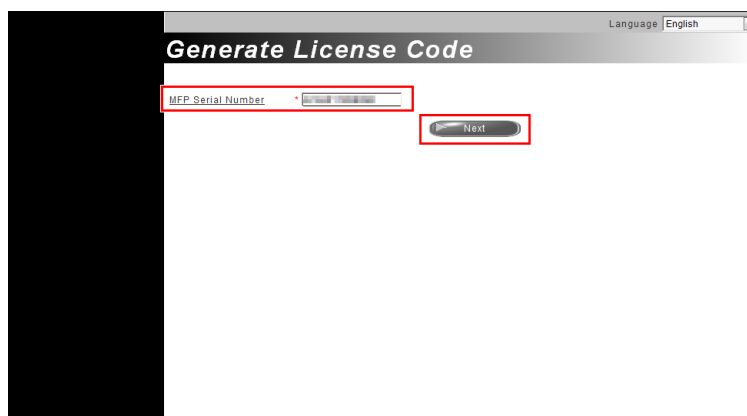

- 4 Check the message, then click [OK].

5 The license code is issued.



Tips

- The issued license code is required to enable Web browser function. You should write them down on a memo pad or print them out on paper by clicking [Print].
- You could also store them in your USB memory device. The license code input could be omitted by using a USB memory device to achieve a convenient operation.
- When using a USB memory device, insert the USB memory device and click [Download] to store the license code.

Enabling the Web browser using the license

Register the license code in this machine.

This procedure is available when this machine cannot be connected to the Internet.

By inputting the codes

- 1 Tap [Utility], and select [Administrator Settings] - [Network Settings] - [Forward] (twice) - [Web Browser Settings] - [Web Browser Usage Settings].

→ For information on the default administrator password, refer to the User's Guide CD/DVD.

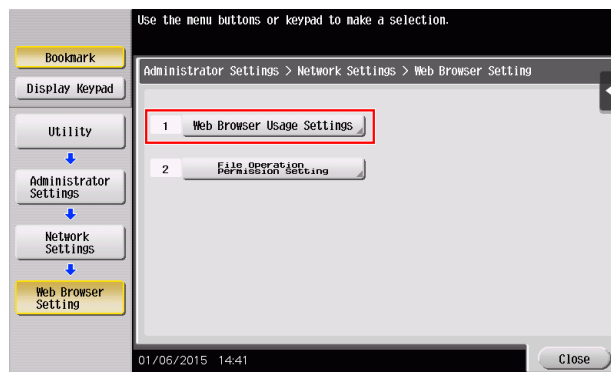

- 2 Select [ON], then tap [OK].

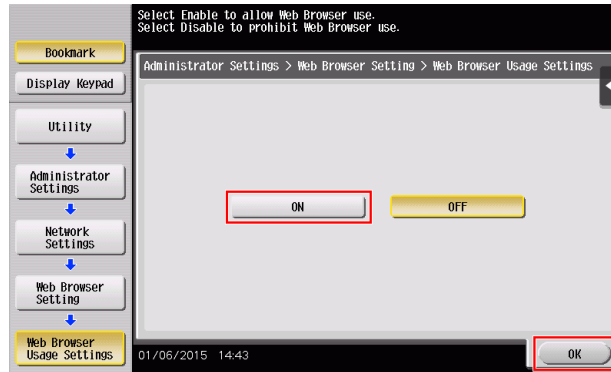

- 3 When the screen shown below appears, tap [Function/License Code].

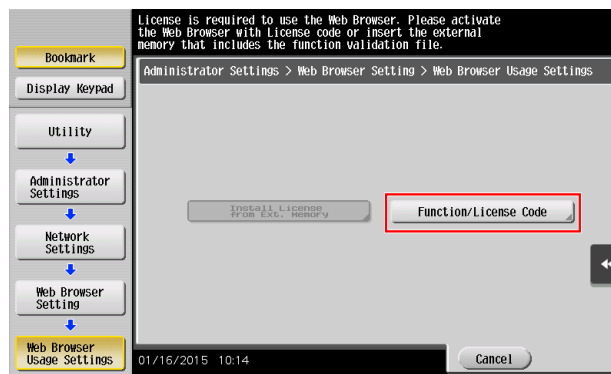

- 4 Enter the license code you wrote down.

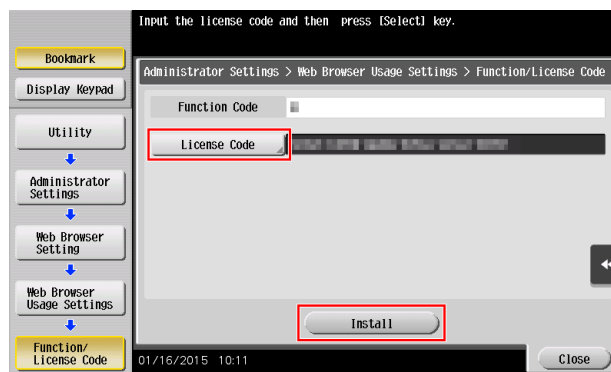

- 5 Select [Yes], then tap [OK].

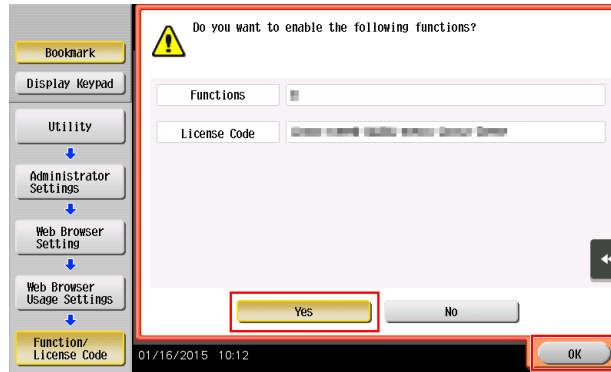

This machine restarts automatically.

By using a USB memory device

- 1 Tap [Utility], and select [Administrator Settings] - [Network Settings] - [Forward] (twice) - [Web Browser Settings] - [Web Browser Usage Settings].

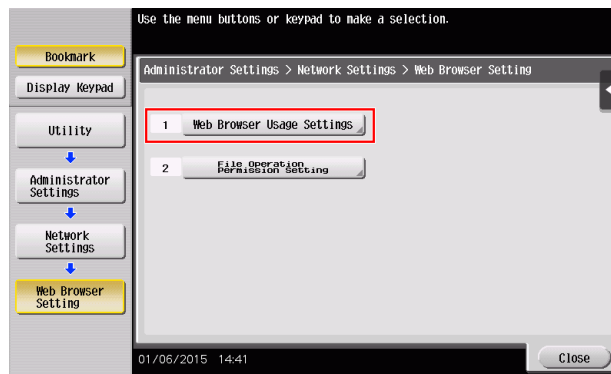

- 2 Select [ON], then tap [OK].

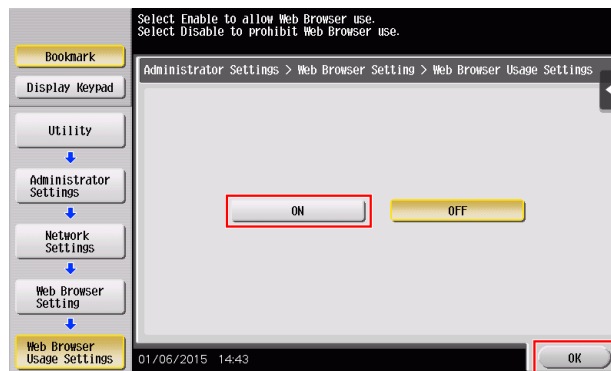

- 3 Wait a few moments until the screen shown below appears.

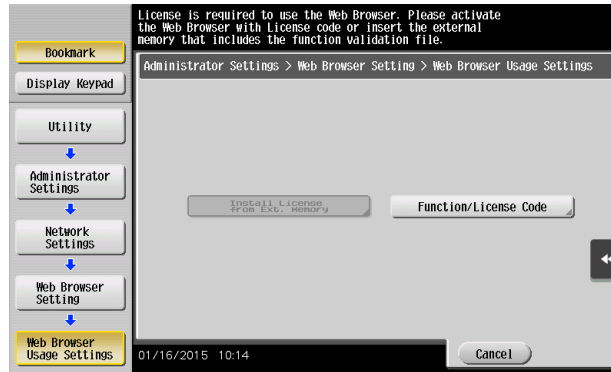

- 4 Connect the USB memory device stored with the license code.

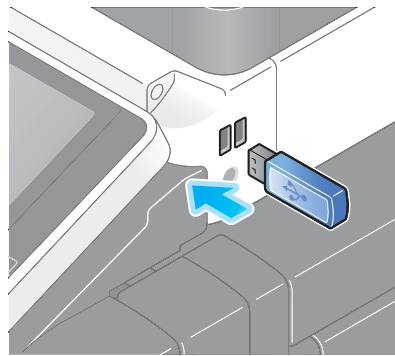

- 5 Select [Install License from Ext. Memory].

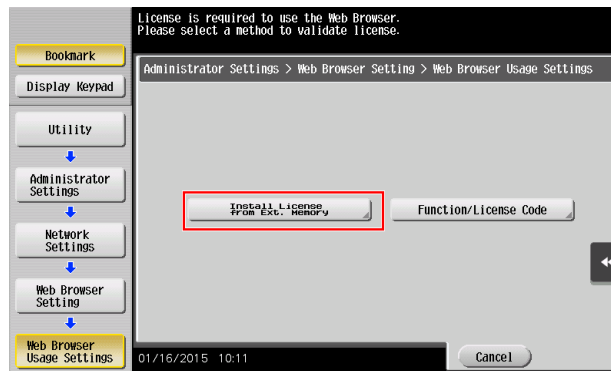

- 6 Select [Yes], then tap [OK].

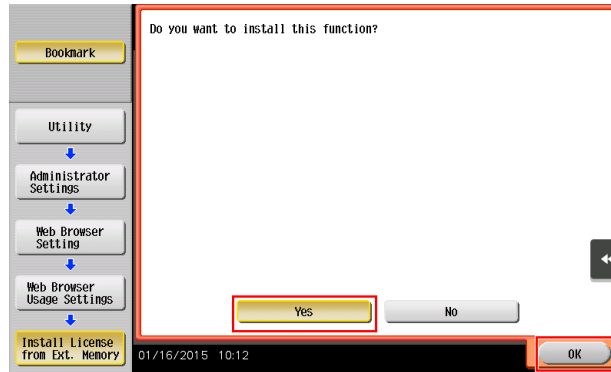

This machine restarts automatically.

Starting the Web browser

- 1 Tap [Web Browser].

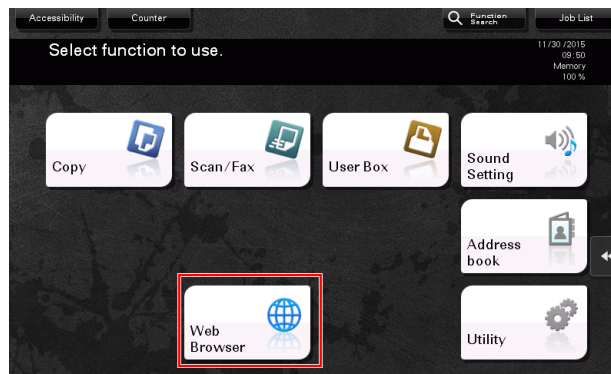

The Web browser starts.

Tips

- The pre-specified home page appears.

Displaying Web pages

- 1 Tap the URL display area.
- 2 Enter the URL of a desired page, then tap [OK].
The target page appears.

Tips

- Selecting [Menu] - [Display] allows you to zoom in and out from a page or change the character code.
- Selecting [Menu] - [Tab] allows you to open a new tab and display a different page.

Printing the currently displayed page or the linked file

For the currently displayed page

- 1 Tap [Print].
- 2 Specify the output paper.
 - To change the setting, tap the desired key on the **Touch Panel**.

Settings	Description
[Color]	Select whether to print in color or black and white mode.
[Simplex/Duplex]	Select whether to print one side or both sides of sheets of paper. To specify 2-sided printing, select the binding position.
[Finishing]	Configure the offset, punch, or staple setting for output paper.

- 3 Press the **Start** key.



For the linked file

This machine provides a capability that prints a PDF file, XPS file, OOXML file, PPML file, or TIFF file.

- 1 Select a link to the printed file.
- 2 Tap [Print].
 - When linking to a PDF file, you can tap [View] to check its contents before printing the file.
- 3 Specify the output paper.
 - To change the setting, tap the desired key on the **Touch Panel**.

Settings	Description
[Color]	Select whether to print in color or black and white mode.
[Simplex/Duplex]	Select whether to print one side or both sides of sheets of paper. To specify 2-sided printing, select the binding position.
[Finishing]	Configure the offset, punch, or staple setting for output paper.

- 4 Press the **Start** key.





5

Troubleshooting

Troubleshooting

5 Troubleshooting

5.1 Main messages and remedies

5.1.1 When a message appears to replace consumables or carry out cleaning

A message appears indicating the time(s) that expiring consumables used in this machine should be replaced. Also, a message appears when the **Slit Scan Glass** is dirty.

Replace consumables mentioned in the displayed message or clean the **Slit Scan Glass**.

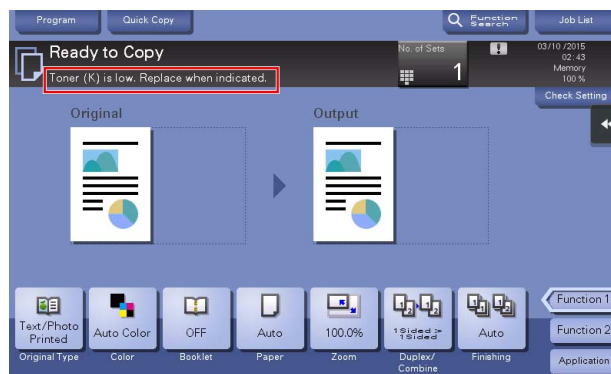

A message recommending that parts be replaced indicates that certain consumables are running out. Although you can still continue to print for a while after the message is displayed, it is advisable to promptly prepare replacement consumables.

- For **Toner Cartridge**: [Toner is low. Replace when indicated.] appears, followed by [Replace Toner Cartridge.]. Replace the Toner Cartridge based on the maintenance contract.
- For **Staple Cartridge/Saddle Staple Cartridge**: When the message [Replace the Staple Cartridge.] or [Replace the Saddle Staple Cartridge 1 or 2.] appears, replace the staples.
- For **Imaging Unit**: When the message [The Imaging Unit needs to be replaced.] appears, replace it based on the maintenance contract.
- For **Waste Toner Box**: When the message [Waste Toner Box needs to be replaced.] appears, replace it based on the maintenance contract.

Contact your service representative if the messages continue to appear even after replacement or cleaning has been carried out.

5.1.2 When a paper jam message persists

There may be a paper jam occurring in sections other than those indicated on the **Touch Panel**. Check the sections again not shown on the **Touch Panel**.

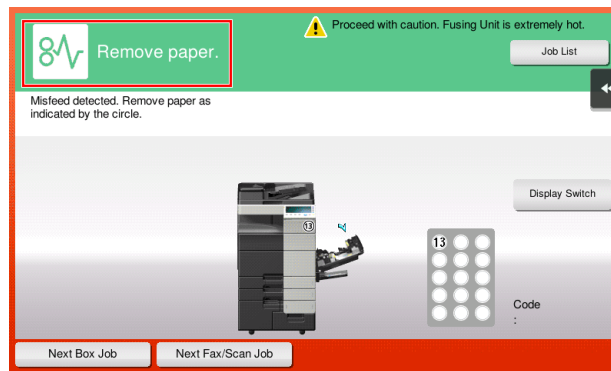

Check the following items:

- Check for any pieces of paper left in the back of the section indicated on the **Touch Panel**. If the paper cannot be easily removed, do not continue; instead contact your service representative.
- Once again, open and close the door at the section with the location number indicated on the **Touch Panel**. This action may clear the message.

Contact your service representative if the paper jam indication persists even after you have checked.

5.1.3 When an error message appears

When an error is detected, the following message appears. Take the appropriate action according to the message displayed on the screen. If you cannot resolve the error, write down the [Trouble Code], and contact your service representative with the power plug disconnected from the power outlet.

In normal circumstances, the phone number and fax number for your service representative appear in the center of the screen.

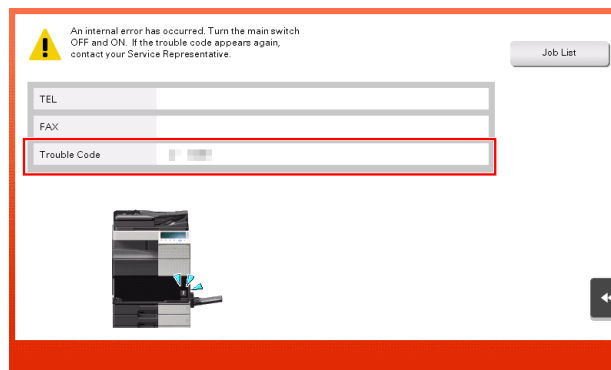

NOTICE

If a defective part can be separated in order to be able to continue operations after a problem has been detected, [Continue] or [Recover Data] is displayed. To continue operations, select any key. However, the problem has not been resolved, so contact your service representative immediately.

5.1.4 When [Stabilizing image.] appears

This automatically performs a function to adjust printing quality in order to maintain a certain level of color reproduction quality. This "printing quality adjustment" is referred to as "image stabilization".

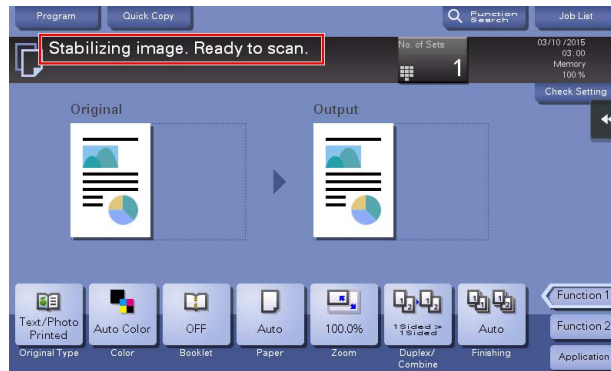

Image stabilization is performed while a large number of copies are being output or the temperature or humidity inside the machine has changed.

Upon completion of image stabilization, printing is automatically resumed. Wait for a moment.

In case image stabilization does not finish after a short while, contact your service representative.

NOTICE

You cannot interrupt or prohibit image stabilization.



Reference

To perform image stabilization on a voluntary basis, refer to the User's Guide CD/DVD.

5.2 When printing quality has deteriorated

5.2.1 Cleaning the Print Head Glass

Printing quality deteriorates if the **Print Head Glass** is dirty. If this occurs, clean the **Print Head Glass** according to the following procedure.

- 1 Pull out **Tray 2**.

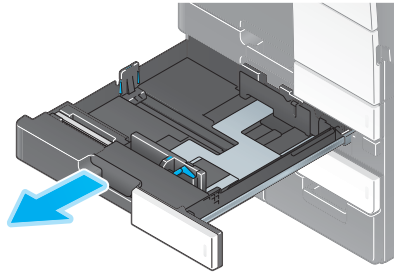

- 2 Remove the **Printhead Cleaner** from **Tray 2**.

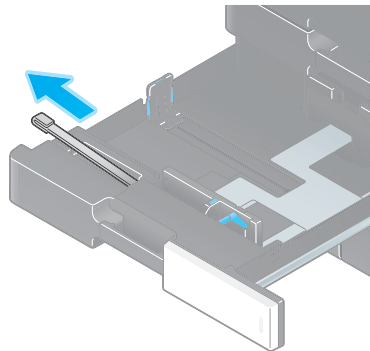

- 3 Open the **Lower Front Door** of the machine.

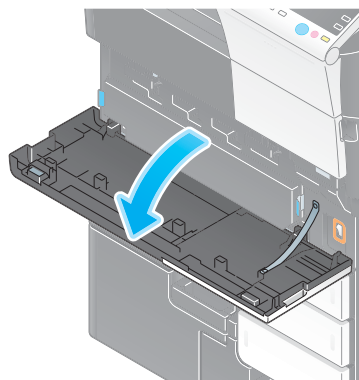

- 4 Release the **Waste Toner Box Lock Lever**, then remove the **Waste Toner Box**.

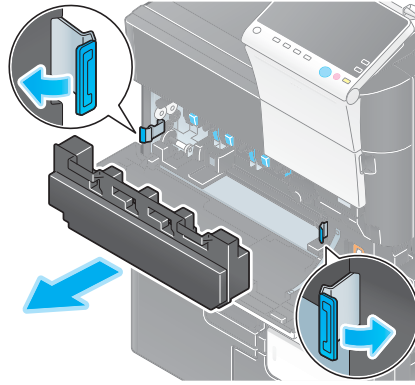

- 5 Slowly insert the **Printhead Cleaner** all the way to the back end of the **Print Head Glass**, and then slowly pull it out.
→ Repeat this operation approximately three times for all the **Print Head Glass** sections.

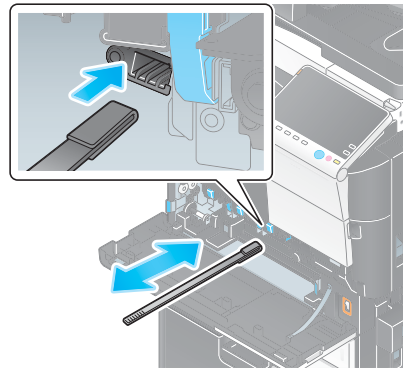

- 6 Install the **Waste Toner Box**.
- 7 Close the **Lower Front Door** of the machine.
- 8 Place back the **Printhead Cleaner** to **Tray 2**.
- 9 Close **Tray 2**.

5.3 When the machine cannot be powered on

This machine has two power sources. Check the **Main Power Switch** and the **Power** key for the status.

- Check whether the power plug of this machine is firmly plugged into the power outlet. Also check that the breaker has not tripped.
- Check to see that the **Main Power Switch** and the **Power** key are turned ON.

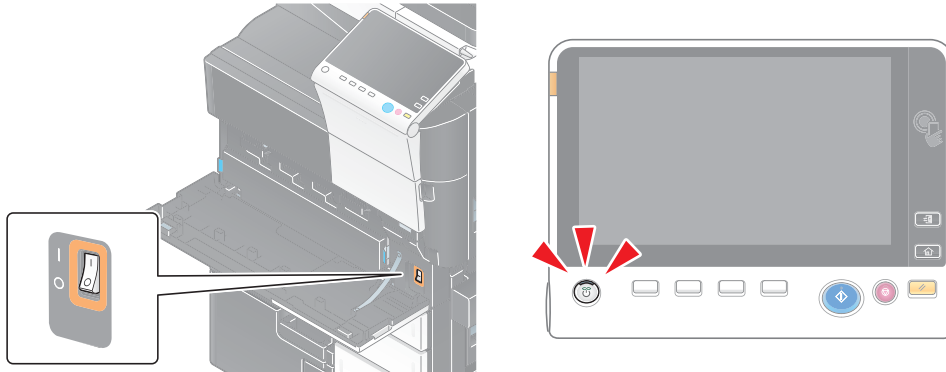

In case the machine cannot be powered on even after checking, contact your service representative.

5.4 When the Touch Panel is not visible

If a certain length of time has elapsed without any operations being carried out on this machine, the **Touch Panel** may turn off.

Check the following items:

- Tap [Accessibility] and select [Brightness Adjustment], and select [Low] or [High] to adjust the contrast for the **Touch Panel**.

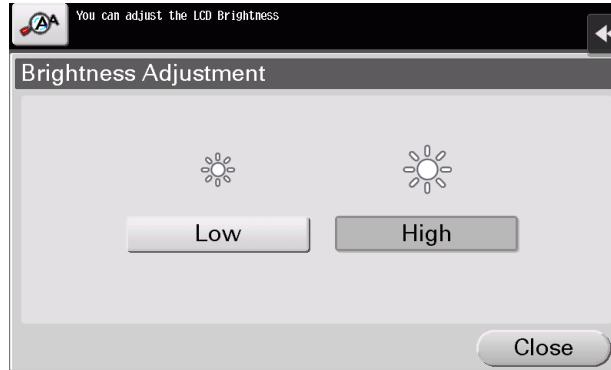

- Touch the **Touch Panel**. In Power Save (Low Power/Sleep) mode, this machine returns from Power Save mode when the **Touch Panel** is touched or a key on the **Control Panel** is pressed, and the **Touch Panel** appears normally.
- On the **Control Panel**, press the **Power** key. If the Weekly Timer setting has put the machine in Erp Auto Power off mode, press the **Power** key to display the **Touch Panel**. To use it outside the preset operating hours, follow the on-screen instructions.

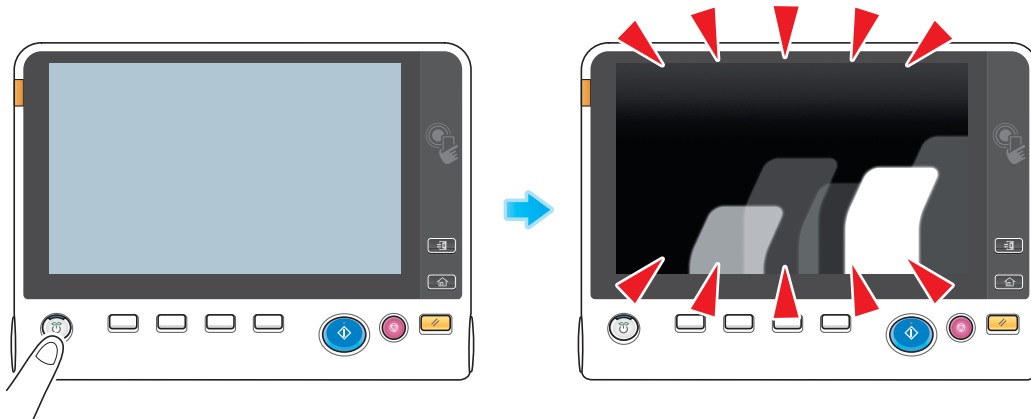

- Check to see that the **Main Power Switch** and the **Power** key are turned ON.

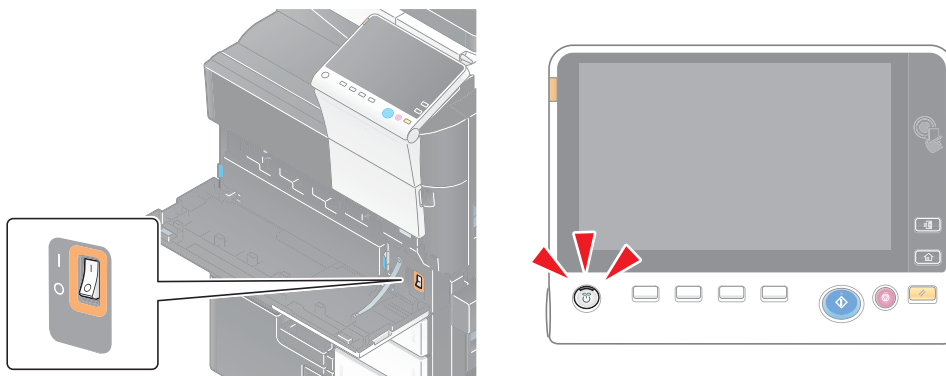

In case the **Touch Panel** does not appear even after checking it, contact your service representative.

5.5 When a message appears to replace consumables or carry out cleaning

When staples in the Finisher have run out

When staples in the **Finisher** have run out, a message appears to prompt you to make replenish them.

Take action while referring to the label inside the machine.

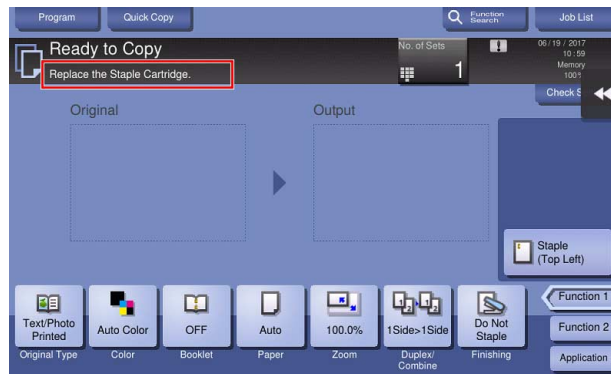
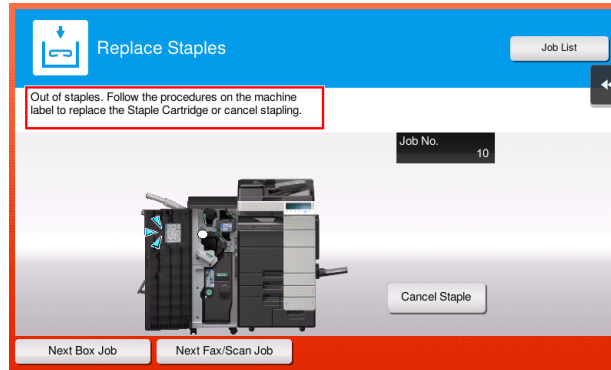

Reference

For details on how to replace a staple cartridge when [Replace the Staple Cartridge.] is displayed, refer to page 5-17.

For details on how to replace a saddle staple cartridge when [Replace the Saddle Staple Cartridge 1 or 2.] is displayed, refer to page 5-19.

When the punch scrap box is full

When the punch scrap box is full, a message appears to prompt you to dispose of the punch scraps (at replacement by user).

Take action while referring to the label inside the machine.

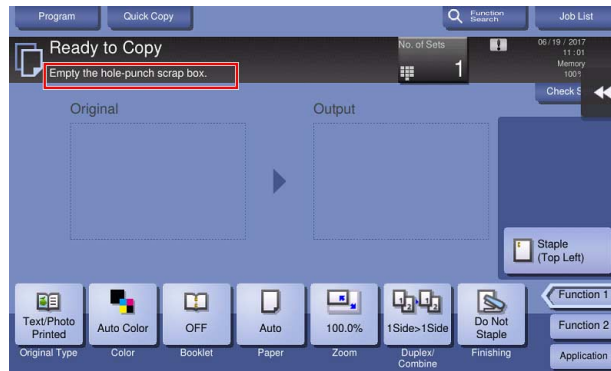

When toner is running out in the Toner Cartridge

When it is almost time to replace a **Toner Cartridge**, an advanced warning message appears. Prepare a replacement **Toner Cartridge** based on the maintenance contract.

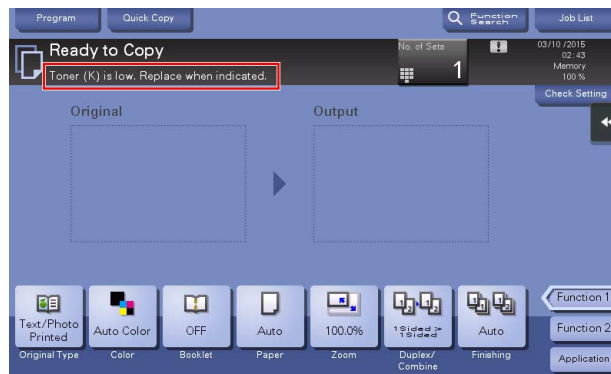

When it is time to replace a Toner Cartridge

When it is time to replace a **Toner Cartridge**, a replacement prompt message appears. Replace it based on the maintenance contract. Tap [Start Guidance] to display the replacement procedure on the screen and check it.



Tips

- Do not replace a **Toner Cartridge** of a color that is not displayed.
- When it is time to replace a **Toner Cartridge** of a color other than black, printing can be forcibly continued using black. Tap [Continue], and then select a desired print job.

When it is time to replace an Imaging Unit

When it is time to replace an **Imaging Unit**, a replacement prompt message appears. Replace it based on the maintenance contract. Tap [Start Guidance] to display the replacement procedure on the screen and check it.

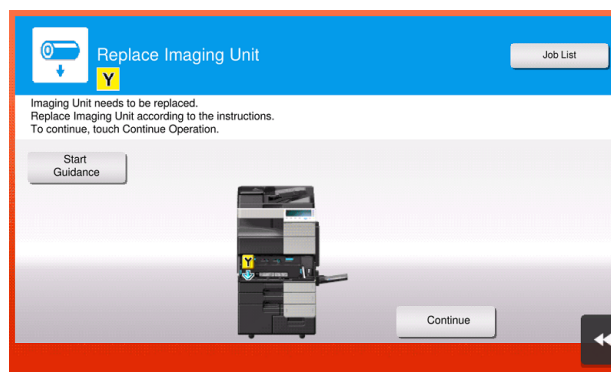

NOTICE

A **Imaging Unit** must not be replaced before the relevant message appears.

Tips

- By the factory default status, this message is displayed only in some area.
- The settings by the service representative are required to display a message about **Imaging Unit**. For details, contact your service representative.
- When it is time to replace an **Imaging Unit** of a color other than black, printing can be forcibly continued using black. Tap [Continue], and then select a desired print job.

When the Waste Toner Box is full

When the **Waste Toner Box** is full, a message appears to prompt you to replace it (at replacement by user). Tap [Start Guidance], then follow the displayed guidance to take an action.

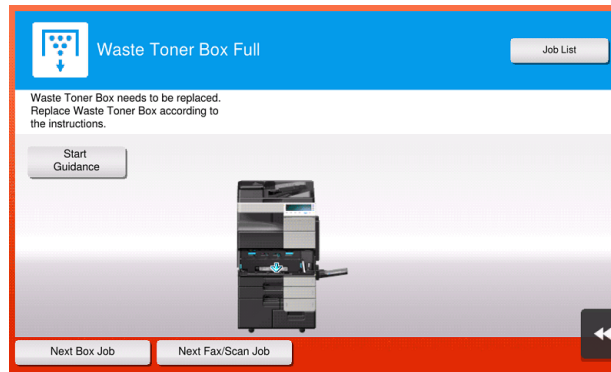

5.5.1 Replacing a Toner Cartridge

The following example shows how to replace a **Black Toner Cartridge**.

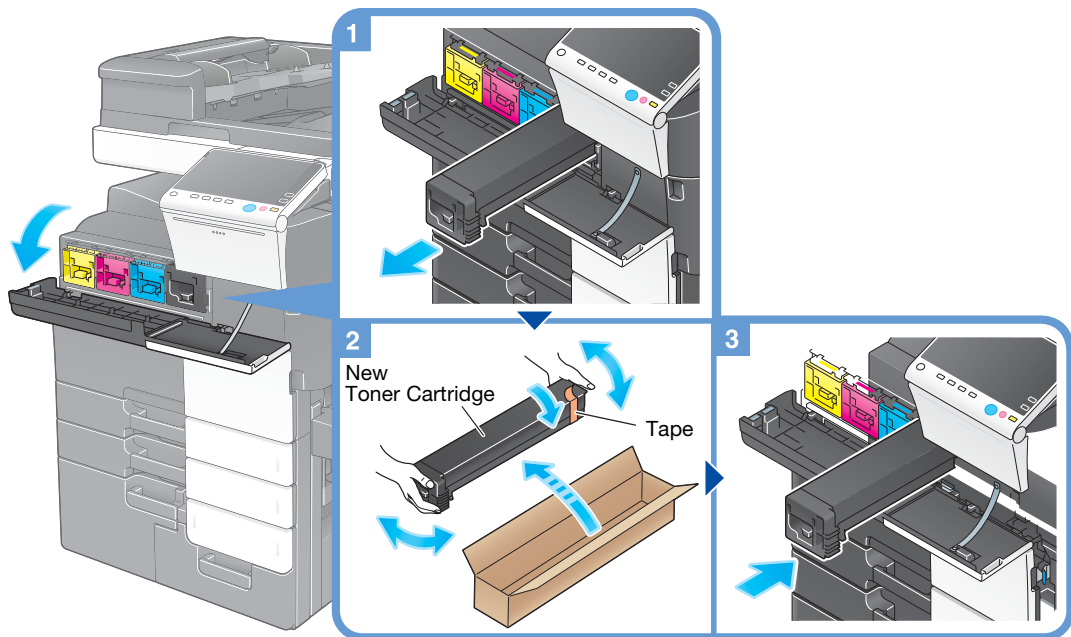

Tips

- Shake a new **Toner Cartridge** well, approximately 5 to 10 times, before installing it.
- If a Toner Cartridge other than for black is empty, printing can be continued forcibly using black. Tap [Continue], and then select a desired print job.
- Do not forcibly open or disassemble a **Toner Cartridge** (toner container).
- Do not forcibly remove or dispose of toner that remains in a **Toner Cartridge** (toner container).

NOTICE

Install a **Toner Cartridge** for each label color. If you try to forcibly install a Toner Cartridge in the incorrect position, it may result in a failure.

⚠ WARNING

- Do not throw toner or a container that contains toner (e.g., toner cartridge, developing unit and Waste Toner Box) into an open flame. The hot toner may scatter and cause burns or other damage.

⚠ CAUTION

- Do not leave toner-related parts (e.g., toner cartridge, developing unit and Waste Toner Box) within easy reach of children. Licking any of these parts or ingesting toner could damage your health.
- Do not store toner-related parts (e.g., toner cartridge, developing unit and Waste Toner Box) near devices susceptible to magnetism, such as precision equipment and data storage devices, otherwise they may malfunction. They could cause these products to malfunction.
- Do not force open the toner-related parts (e.g., toner cartridge, developing unit and Waste Toner Box). If toner tumbles from the toner bottle, take utmost care to avoid inhaling it or even getting skin contact.
- If toner lands on your skin or clothing, wash thoroughly with soap and water.
- If you inhale toner, move to a place with fresh air and gargle with a lot of water repeatedly. Should you get symptoms such as coughing, seek medical advice.
- If you get toner into your eyes, immediately rinse them with running water for over 15 minutes. Seek medical advice if irritation persists.
- If you swallow toner, rinse out your mouth and drink a few glasses of water. Seek medical advice if necessary.

5.5.2 Replacing a Waste Toner Box

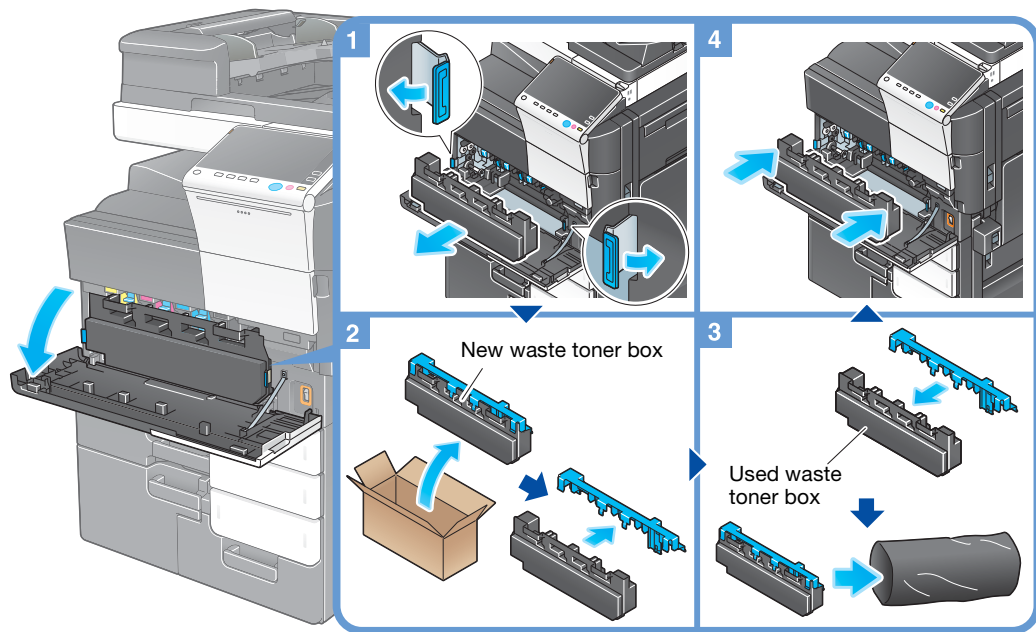

Tips

- After removing the **Waste Toner Box**, quickly install the cap. If the **Waste Toner Box** is tilted, waste toner may spill.
- Your service representative will collect your used **Waste Toner Box**. Place a cap on it, put it in a plastic bag, and store it in a box by itself.

⚠ WARNING

- Do not throw toner or a container that contains toner (e.g., toner cartridge, developing unit and Waste Toner Box) into an open flame. The hot toner may scatter and cause burns or other damage.

⚠ CAUTION

- Do not leave toner-related parts (e.g., toner cartridge, developing unit and Waste Toner Box) within easy reach of children. Licking any of these parts or ingesting toner could damage your health.
- Do not store toner-related parts (e.g., toner cartridge, developing unit and Waste Toner Box) near devices susceptible to magnetism, such as precision equipment and data storage devices, otherwise they may malfunction. They could cause these products to malfunction.
- Do not force open the toner-related parts (e.g., toner cartridge, developing unit and Waste Toner Box). If toner tumbles from the toner bottle, take utmost care to avoid inhaling it or even getting skin contact.
- If toner lands on your skin or clothing, wash thoroughly with soap and water.
- If you inhale toner, move to a place with fresh air and gargle with a lot of water repeatedly. Should you get symptoms such as coughing, seek medical advice.
- If you get toner into your eyes, immediately rinse them with running water for over 15 minutes. Seek medical advice if irritation persists.
- If you swallow toner, rinse out your mouth and drink a few glasses of water. Seek medical advice if necessary.

5.5.3 Replacing an Imaging Unit

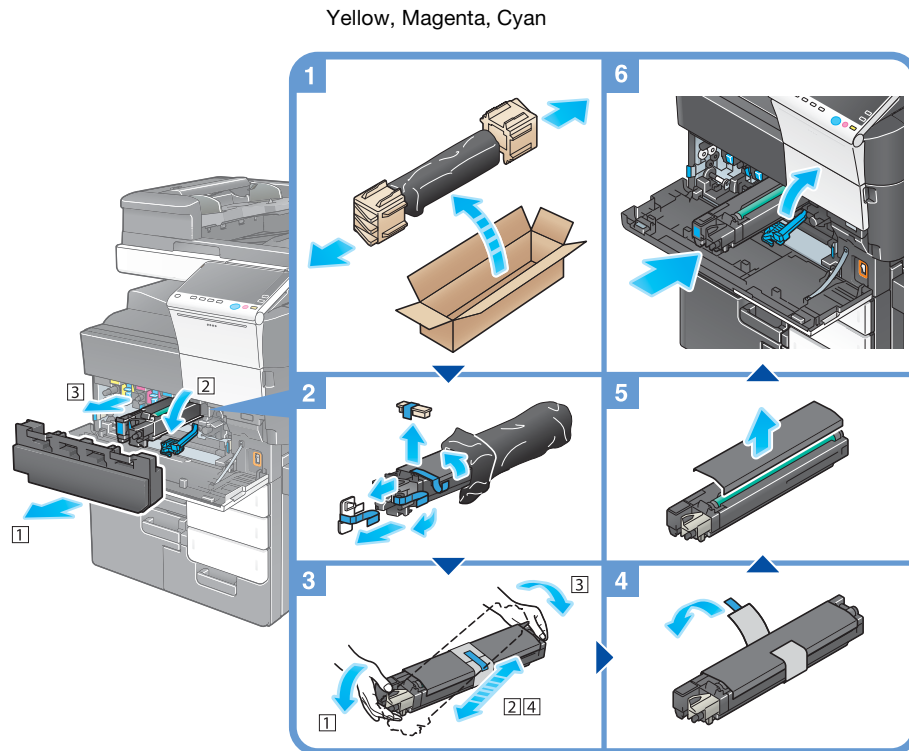

Tips

- Your service representative will collect your used **Imaging Unit**. Put it in a black plastic bag and store it in a box by itself.
- An **Imaging Unit** may be damaged due to exposure to light. Do not take it out of a black plastic bag until just before it is to be installed.
- If an **Imaging Unit** other than for black has reached the replacement time, printing can be continued forcibly using black. Tap [Continue], and then select a desired print job.
- After replacing an **Imaging Unit**, be sure to clean the **Print Head Glass** for each color. For details on how to clean the **Print Head Glass**, refer to page 5-6.

⚠ WARNING

- Do not throw toner or a container that contains toner (e.g., toner cartridge, developing unit and Waste Toner Box) into an open flame. The hot toner may scatter and cause burns or other damage.

⚠ CAUTION

- Do not leave toner-related parts (e.g., toner cartridge, developing unit and Waste Toner Box) within easy reach of children. Licking any of these parts or ingesting toner could damage your health.
- Do not store toner-related parts (e.g., toner cartridge, developing unit and Waste Toner Box) near devices susceptible to magnetism, such as precision equipment and data storage devices, otherwise they may malfunction. They could cause these products to malfunction.
- Do not force open the toner-related parts (e.g., toner cartridge, developing unit and Waste Toner Box). If toner tumbles from the toner bottle, take utmost care to avoid inhaling it or even getting skin contact.
- If toner lands on your skin or clothing, wash thoroughly with soap and water.
- If you inhale toner, move to a place with fresh air and gargle with a lot of water repeatedly. Should you get symptoms such as coughing, seek medical advice.
- If you get toner into your eyes, immediately rinse them with running water for over 15 minutes. Seek medical advice if irritation persists.
- If you swallow toner, rinse out your mouth and drink a few glasses of water. Seek medical advice if necessary.

5.5.4 Replacing a Staple Cartridge

Finisher FS-537/Finisher FS-537 SD

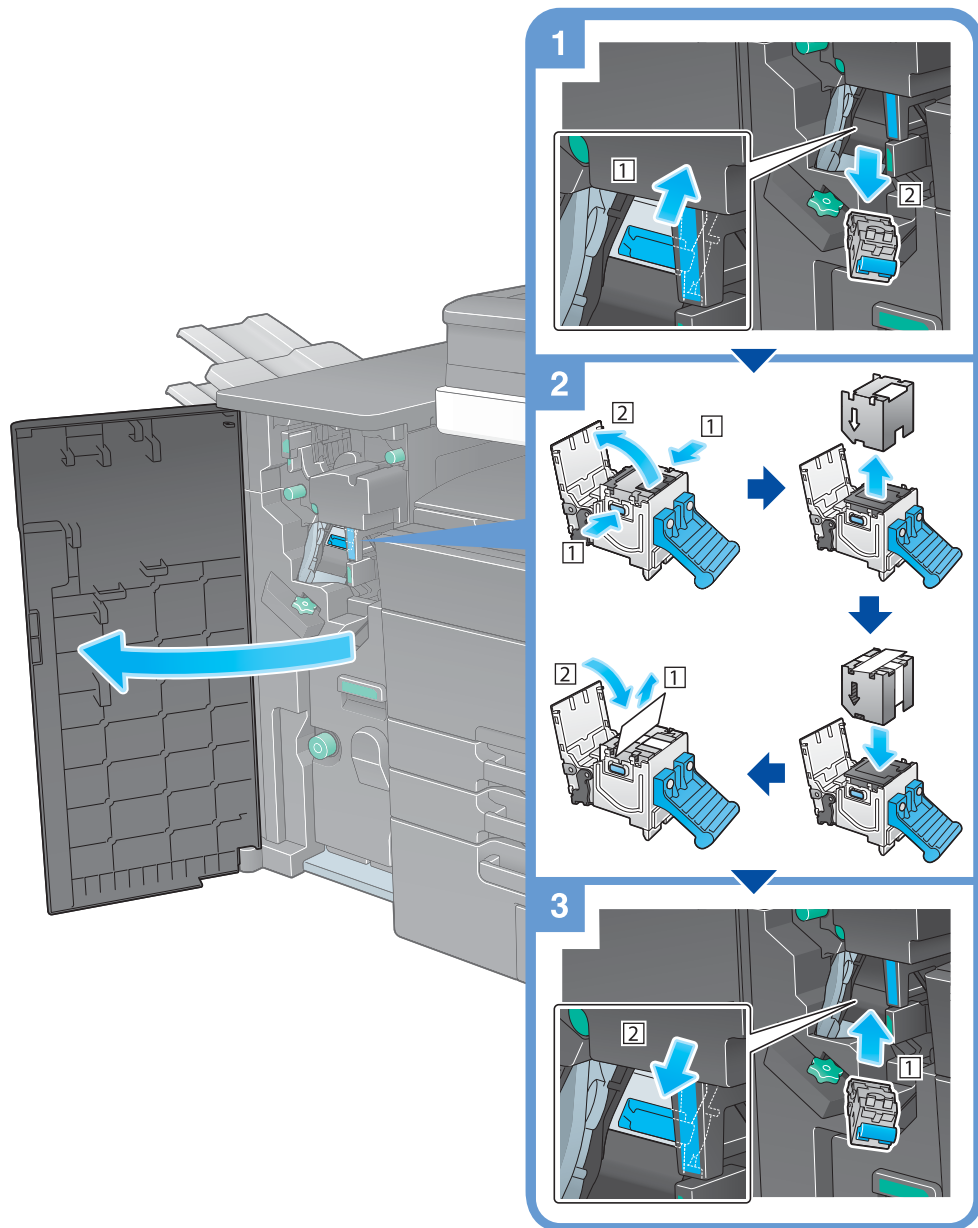

Tips

- The figure shows the **Finisher FS-537 SD** equipped with **Punch Kit PK-523**, **Z Folding Unit ZU-609**, and **Relay Unit RU-515**.
- Do not remove staples that remain in the machine. Otherwise, the stapling function will activate but no sheets will be stapled.

NOTICE

Be sure to replace the **Staple Cartridge** after the relevant message has appeared. If a **Staple Cartridge** is removed before the relevant message appears, it may result in a failure.

Finisher FS-536/Finisher FS-536 SD

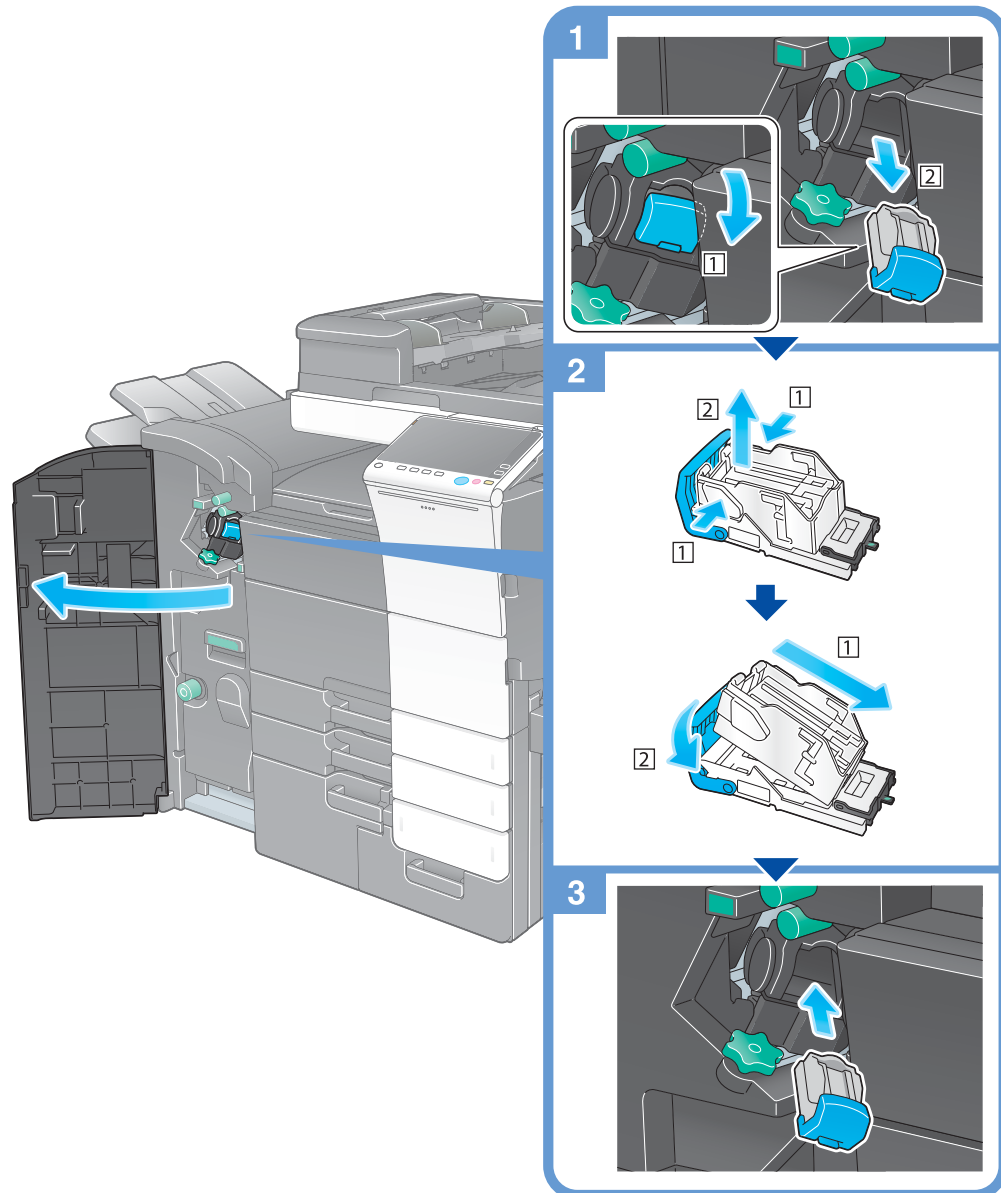

Tips

- The figure shows the **Finisher FS-536 SD** equipped with **Punch Kit PK-520** and **Relay Unit RU-515**.
- Do not remove staples that remain in the machine. Otherwise, the stapling function will activate but no sheets will be stapled.

NOTICE

Be sure to replace the **Staple Cartridge** after the relevant message has appeared. If a **Staple Cartridge** is removed before the relevant message appears, it may result in a failure.

5.5.5 Replacing a Saddle Staple Cartridge

Finisher FS-537 SD

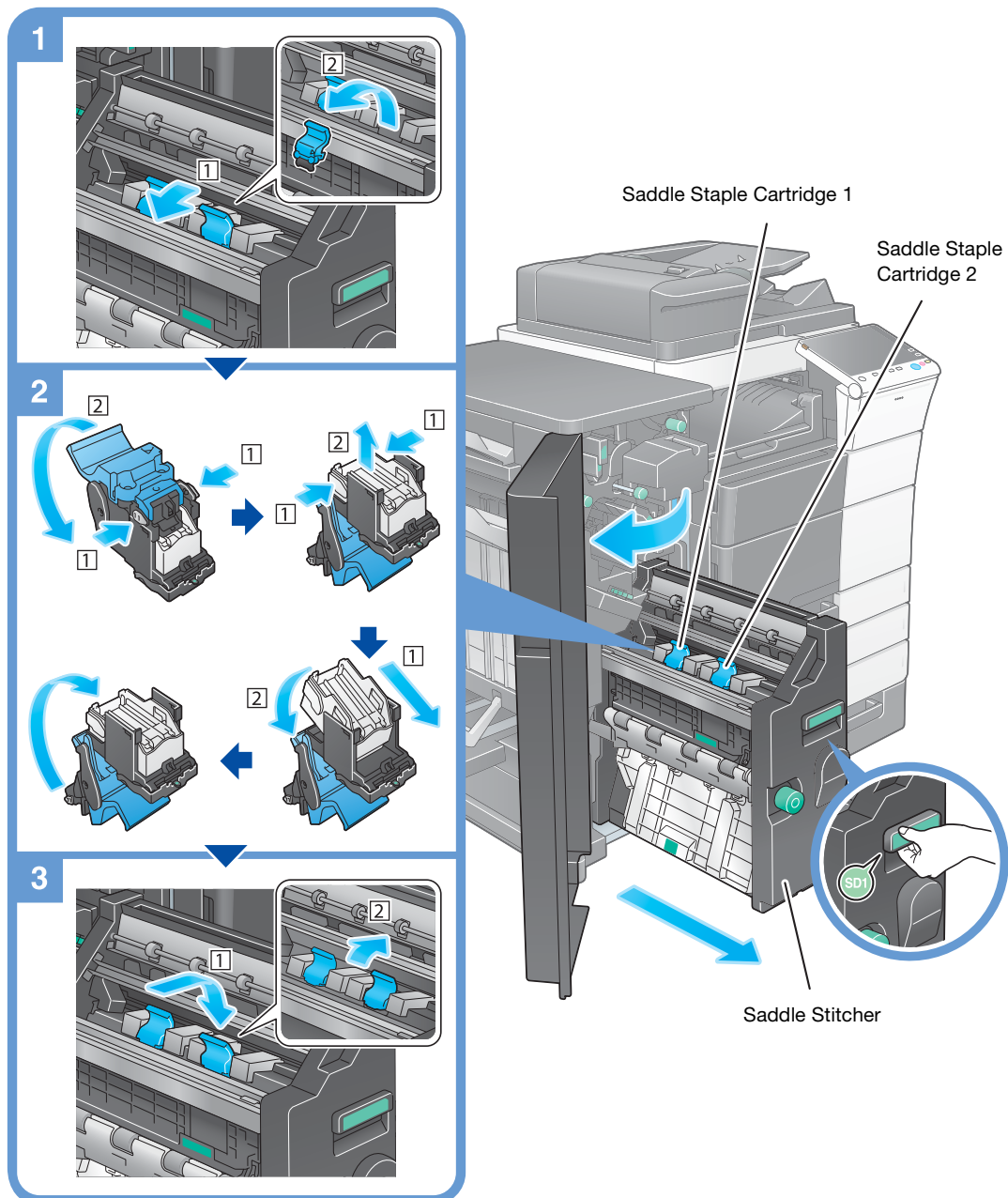

Tips

- The figure shows the **Finisher FS-537 SD** equipped with **Punch Kit PK-523**, **Z Folding Unit ZU-609**, and **Relay Unit RU-515**.
- Do not remove staples that remain in the machine. Otherwise, the stapling function will activate but no sheets will be stapled.

NOTICE

When moving the **Saddle Sticher**, be sure to only hold the handle. Otherwise, your hand or finger may get caught in the machine.

Be sure to replace the **Saddle Staple Cartridge** after the relevant message has appeared. If a **Saddle Staple Cartridge** is removed before the relevant message appears, it may result in a failure.

Finisher FS-536 SD

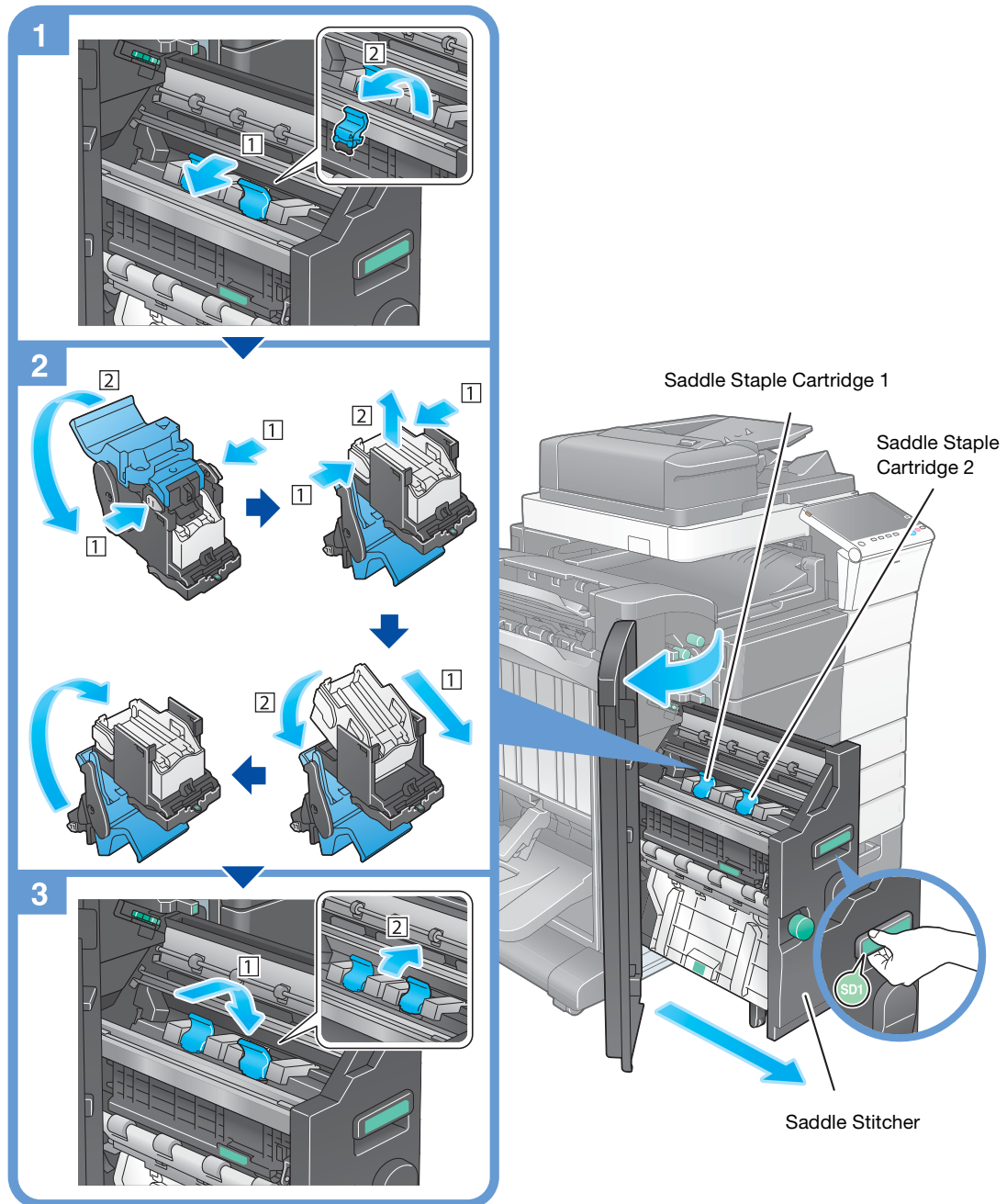

Tips

- The figure shows the **Finisher FS-536 SD** equipped with **Punch Kit PK-520** and **Relay Unit RU-515**.
- Do not remove staples that remain in the machine. Otherwise, the stapling function will activate but no sheets will be stapled.

NOTICE

When moving the **Saddle Sticher**, be sure to only hold the handle. Otherwise, your hand or finger may get caught in the machine.

Be sure to replace the **Saddle Staple Cartridge** after the relevant message has appeared. If a **Saddle Staple Cartridge** is removed before the relevant message appears, it may result in a failure.



6

Index

6 Index

A

Address Book 3-49
Advanced Functions 4-3

C

Control Panel 2-22
Copy function 3-46

D

Dialing Method 3-39

E

E-mail TX 3-28
Entering Characters 2-31
ErP Auto Power OFF 2-21

F

Fax TX 3-36

G

Group 3-58
Guidance function 3-68

H

Help Menu 3-68, 3-72

I

Installing the fax driver 3-45
Installing the printer driver 3-5, 3-9
i-Option 4-4

J

Job 2-32

K

Keypad 2-29

L

License Management Server (LMS) 4-6, 4-12
Loading Paper 2-33, 2-34, 2-36, 2-37
Low Power mode 2-21

M

Main Menu 2-24
MFP 2-10
Multi-job 2-32

O

Options 2-7, 2-12

P

PC-Fax TX 3-42
PCL 3-5
Power Save mode 2-21
Print Function 3-3, 3-6
Printing from a USB memory device 3-62
PS 3-5

Q

Quick Security 3-73

R

Request Code 4-6

S

Safety information 1-6
Saving the scanned data 3-64
Search 3-60
Sender Fax No. Settings 3-37
Sender settings 3-37
Sleep mode 2-21
Slide Menu 2-25
SMB Send 3-12, 3-20
Sub Power OFF 2-20

T

Token Certificate 4-5
Touch Panel 2-24, 2-26

U

User authentication 3-48

W

Web Browser 4-10

